



2022

PURE PASSION



DINARSKA PROTIVREDNOST VALUTE



2022

COMPUTERS

SMART APNEA

Code: 424153

RRP
€ 299.00



- SEGMENTED LCD DISPLAY
- INSTANTANEOUS DEPTH, DIVE TIME, RECOVERY TIME, TEMPERATURE
- DESCENT AND ASCENT RATE
- CUSTOMIZABLE ALARMS (DEPTH, TIME, SPEED, HYDRATION, RECOVERY TIME)
- ONE SECOND SAMPLING RATE
- ADVANCED PERFORMANCE MICROPROCESSOR
- LATEST GENERATION DEPTH SENSOR
- UPDATABLE FIRMWARE AND DATA DOWNLOAD WITH AFTERMARKET DIVE LINK INTERFACE



COLOR VARIATIONS



BKWH

BKBL

BKGR

BKOR

TECHNICAL FEATURES

Battery	Type	CR2430
	Duration	Approx. 200 hours of diving over a 2 year time span
Max displayed depth		150m
Resolution		Resolution 0.1m until 99.9m - 1m at depth deeper than 100m In ft. it is always 1ft
Temperature		-10 °C to +50 °C
Logbook memory		20-30 hours of dive profile at 1-second sampling rate
Display		Mineral glass - Diagonal 31 mm
Clock		Quartz clock, time, date, dive time, displays up to 999 minutes

DISPLAYS (SCALE 1:1)



Time mode



Surface display



Dive mode



Programmable alarm

BLUELINK PRO

Code: 414317

RRP
€ 72.00

- TO DOWNLOAD THE LOGBOOK OF A DIVE COMPUTER USING THE BLUETOOTHLOW ENERGY TECHNOLOGY (QUAD, QUAD AIR, PUCK PRO +, SMART, SMART AIR)
- REQUIRES THE DIVESSI APP (ANDROID, IOS).



DIVE LINK 2 USB

Code: 414316

RRP
€ 65.00

- FOR DOWNLOADING THE DIVE COMPUTER MEMORY TO PC OR MAC (QUAD, QUAD AIR, PUCK PRO +, SMART, SMART AIR)
- REQUIRED SOFTWARE: DIVE ORGANIZER (PC)



SMART DISPLAY PROTECTOR

Code: 415173

RRP
€ 35.00

- PERFECT FIT AND EASE OF INSTALLATION
- AVOIDS SCRATCHES, DIRT AND SAND
- SOFT AND DURABLE
- ULTRA TRANSPARENT
- SOLD IN A PACK OF 2



DIVE ORGANIZER

- FULL-FEATURED LOGBOOK MANAGEMENT SOFTWARE
- ALLOWS UPGRADING OF FIRMWARE ON COMPATIBLE DIVE COMPUTERS
- ALLOWS UPLOADING OF MAPS AND IMAGES TO ICON HD
- FEATURES TISSUE SATURATION GRAPH WITH DETAILED EVOLUTION DURING THE DIVE
- FOR PC ONLY

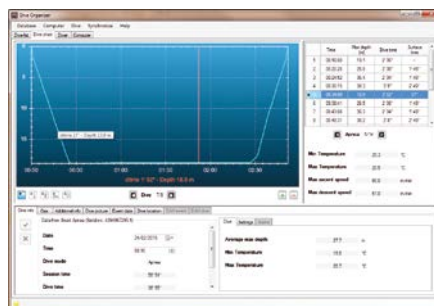

MISSION DIGITAL CHRONO SF

Code: 424154

RRP
€ 299.00

- DIGITAL CHRONOGRAPH WITH BACK LIGHT
- DEPTH RATED TO 200M / 660FT
- HIGH-QUALITY SWISS QUARTZ MOVEMENT
- DAILY ALARM AND HOURLY TIME SIGNAL
- COUNTDOWN TIMER
- DIGITAL TIMEZONE AND DATE
- SECOND DIGITAL TIMEZONE
- FLUORESCENT DIGITS
- STAINLESS STEEL
- ADJUSTABLE STRAP





2022

FINS



X-WING FOOT POCKET

Code: 420924

RRP
€ 49.00

- NO BLADE SIDE RIBS
- VERY LIGHTWEIGHT - SIZE 42-43 WEIGHS 270G
- PREFORMED 30° ANGLE
- ERGONOMIC, ULTRA-REACTIVE FOOTPOCKET MADE IN 2 MATERIALS, DESIGNED TO TRANSMIT ENERGY TO THE FIN IN THE MOST EFFECTIVE WAY, OPTIMIZING EFFORT AND IMPROVING PERFORMANCE
- STIFFENED SOLE TO AVOID DEFORMATION OF THE FOOTPOCKET UNDER BLADE LOAD AND ROTATION IN THE LONGITUDINAL AXIS
- DESIGNED TO BE WORN ALSO WITHOUT NEOPRENE SOCKS
- PACK INFO: SOLD SINGLY

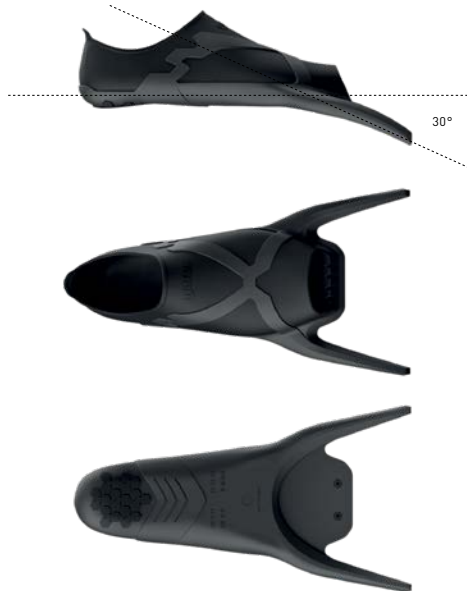

TECHNICAL FEATURES

Sizes	036 - 038 - 040 - 042 - 044 - 046
-------	-----------------------------------

X-WING BLADE FIXING SET

Code: 420925

RRP
€ 7.00

- PACK INFO: SOLD SINGLY



X-WING FIN BLADES

X-WING CARBON FIN BLADE

Code: 420918 SFT/MED

RRP
€ 189.00

X-WING APNEA FIN BLADE

Code: 420919 SFT/MED

RRP
€ 175.00

X-WING APNEA S FIN BLADE

Code: 420920

RRP
€ 169.00

X-WING PRO FIN BLADE

Code: 420923

RRP
€ 39.00

X-WING PRO BWN FIN BLADE

Code: 420929 **NEW**

RRP
€ 39.00

X-WING FIN BLADE

Code: 420922

RRP
€ 39.00



X-WING

BI - MATERIAL

The new variable thickness footpocket provides the best of both worlds. The thicker "X" areas of the footpocket are designed to transmit the energy produced from the leg into the blade with zero dispersion and loss of energy.

The footpocket is constructed of a soft material ensuring maximum comfort and fit.

The lateral side ribs have been shortened to a minimum, exploiting the best of the elastic and mechanical properties of the blade.

Sizing of the foot-pocket is measured on actual barefoot size, including a smaller range for more fitting options.

The new X-WING foot-pocket is among the lightest in the market and designed to exploit our new 30-degree incline blade, resulting in pure comfort and maximum thrust / performance.

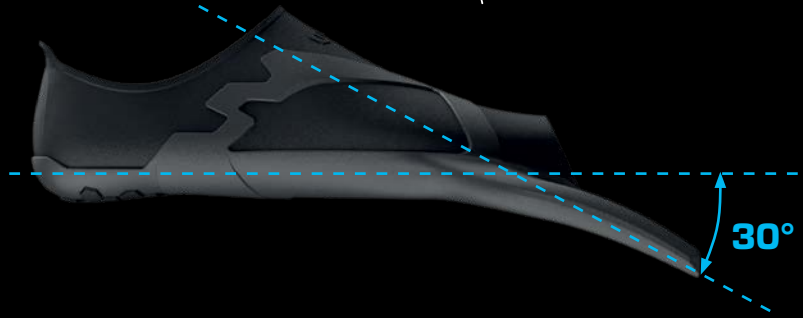
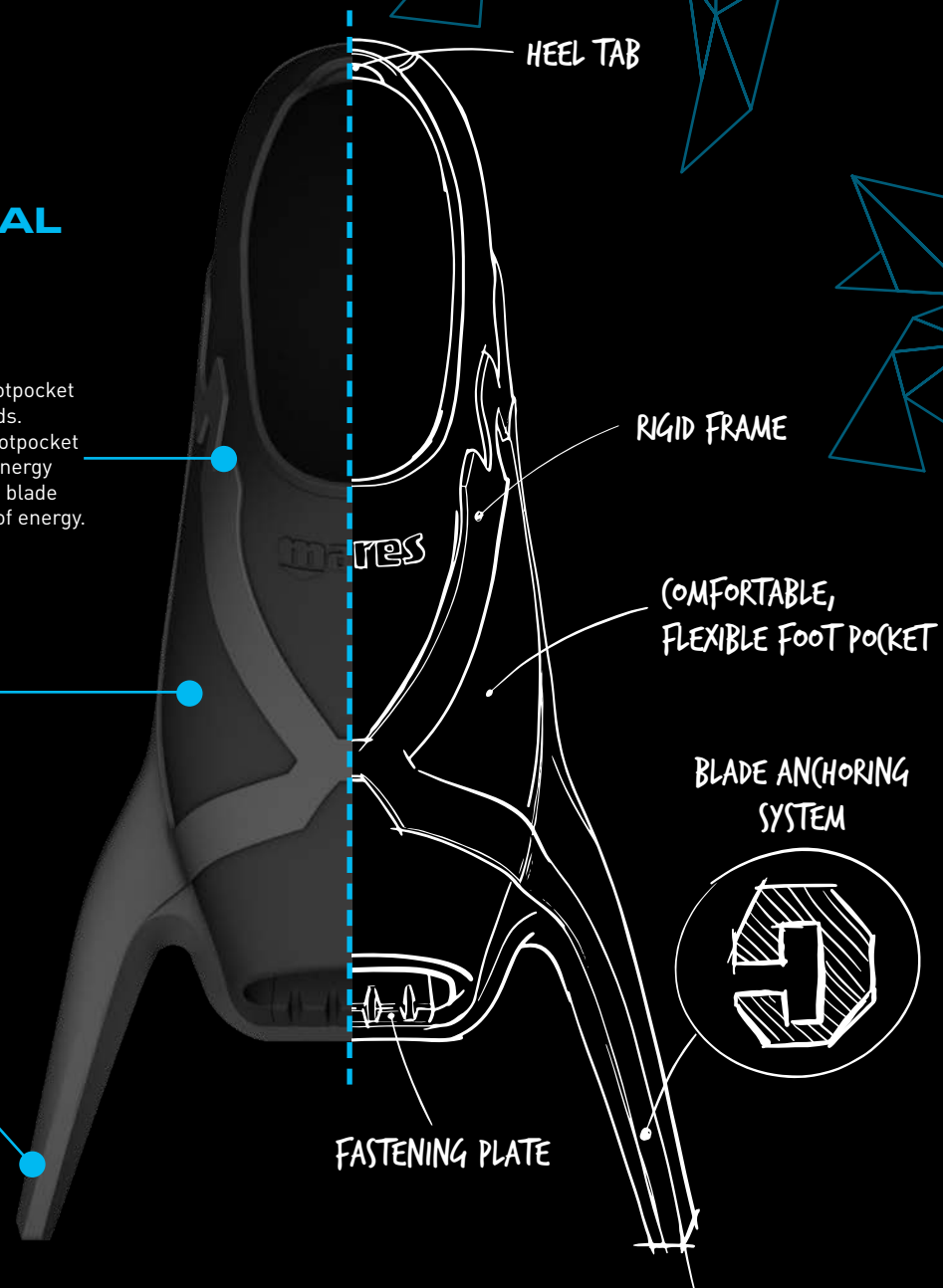

X-WING CARBON

Code: 420415 SFT/MED

RRP
€ 419.00



- BLADE PRODUCED WITH PRE-IMPREGNATED CARBON AND FIBERGLASS LAYERS
- 3K CARBON WITH FIBERS WOVEN AT 90°
- FIBERS CROSS OVER EACH OTHER FEWER TIMES, INCREASING THE RESPONSIVENESS OF THE BLADE
- VARIABLE BLADE THICKNESS AND HIGH-PERFORMING PARABOLIC FLEXION
- THE BLADE IS 200 MM WIDE AND 693 MM LONG
- HIGH-QUALITY MANUFACTURING PROCESS
- VARIABLE SIDE RIBS SUPPORT AND OPTIMIZE CHANNEL THRUST AND FLEX
- AVAILABLE WITH A SOFT OR MEDIUM STRENGTH BLADE DEPENDING ON THE USER'S WEIGHT
- LONGER FINS, ADAPTED TO HIGH KICK FREQUENCY
- 30° BLADE INCLINATION RELATIVE TO THE FOOT POCKET
- THE X-WING FOOT POCKET IS DESIGNED TO BE WORN ALSO WITHOUT A NEOPRENE SOCK
- INTERCHANGEABLE BLADE CONSTRUCTION

TECHNICAL FEATURES

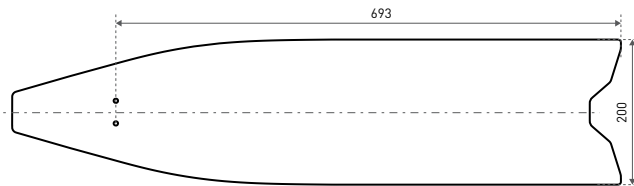

Sizes			Length	Width
EU	UK	USA		
36/37	4/4.5	4.5/5	917mm	200mm
38/39	5.5/6.5	6/7	931mm	200mm
40/41	6.5/7.5	7/8	938mm	200mm
42/43	8/9	8.5/9.5	952mm	200mm
44/45	10/10.5	10/11	971mm	200mm
46/47	11.5/12	12/13	980mm	200mm

Blade material	Carbon and Fiberglass
----------------	-----------------------

SPARE PARTS

X-Wing Foot Pocket	420924	Page 196
X-Wing Blade Fixing Set	420925	Page 196
X-Wing Fin Blade	420918	Page 196

ACCESSORIES

Razor Fin Insole	423943	Page 208
------------------	--------	----------

X-WING APNEA

Code: 420416 SFT/MED

RRP
€ 389.00

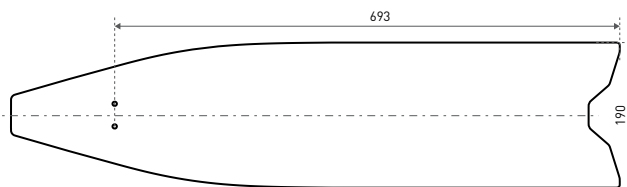

- BLADE PRODUCED WITH PRE-IMPREGNATED FIBERGLASS LAYERS
- VARIABLE BLADE THICKNESS AND HIGH-PERFORMING PARABOLIC FLEXION
- THE BLADE IS 190 MM WIDE AND 693 MM LONG
- HIGH-QUALITY MANUFACTURING PROCESS
- VARIABLE SIDE RIBS SUPPORT AND OPTIMIZE CHANNEL THRUST AND FLEX
- AVAILABLE WITH A SOFT OR MEDIUM STRENGTH BLADE DEPENDING TO THE USER'S WEIGHT
- LONGER FINS, ADAPTED TO MEDIUM KICK FREQUENCY
- BLUE POLYGON BLADE FOR BETTER RECOGNITION IN THE DEEP
- 30° BLADE INCLINATION RELATIVE TO THE FOOT POCKET
- THE X-WING FOOT POCKET IS DESIGNED TO BE WORN ALSO WITHOUT NEOPRENE SOCKS
- INTERCHANGEABLE BLADE CONSTRUCTION

TECHNICAL FEATURES

Sizes			Length
EU	UK	USA	
36/37	3/4	4/5	917mm
38/39	5/6	6/7	931mm
40/41	6.5/7.5	7/8	938mm
42/43	8/9	8.5/9.5	952mm
44/45	10/10.5	10/11	971mm
46/47	11.5/12	12/13	980mm

Blade material	Fiberglass
----------------	------------

SPARE PARTS

X-Wing Foot Pocket	420924	Page 196
X-Wing Blade Fixing Set	420925	Page 196
X-Wing Apnea Fin Blade	420919	Page 196

ACCESSORIES

Razor Fin Insole	423943	Page 208
------------------	--------	----------

X-WING APNEA S

Code: 420417

RRP
€ 389.00



- BLADE PRODUCED WITH PRE-IMPREGNATED FIBERGLASS LAYERS
- VARIABLE BLADE THICKNESS AND HIGH-PERFORMING PARABOLIC FLEXION
- THE BLADE IS 190 MM WIDE AND 613 MM LONG
- HIGH-QUALITY MANUFACTURING PROCESS
- VARIABLE SIDE RIBS SUPPORT AND OPTIMIZE CHANNEL THRUST AND FLEX
- BLACK & WHITE POLYGON BLADE FOR BETTER RECOGNITION IN THE DEEP
- AVAILABLE WITH MEDIUM STRENGTH BLADE
- 30° BLADE INCLINATION RELATIVE TO THE FOOT POCKET
- THE X-WING FOOT POCKET IS DESIGNED TO BE WORN ALSO WITHOUT NEOPRENE SOCKS
- INTERCHANGEABLE BLADE CONSTRUCTION

TECHNICAL FEATURES



Sizes			Length
EU	UK	USA	
36/37	3/4	4/5	837mm
38/39	5/6	6/7	851mm
40/41	6.5/7.5	7/8	858mm
42/43	8/9	8.5/9.5	872mm
44/45	10/10.5	10/11	891mm
46/47	11.5/12	12/13	900mm

Blade material	Fiberglass
----------------	------------

SPARE PARTS

X-Wing Foot Pocket	420924	Page 196
X-Wing Blade Fixing Set	420925	Page 196
X-Wing Apnea S Fin Blade	420920	Page 196

ACCESSORIES

Razor Fin Insole	423943	Page 208
------------------	--------	----------

MAIN FEATURES / FINS

MANUFACTURING PROCESS

Composite fin blades are manufactured in a high-pressure press, reaching 15kg/cm². This process allows for precise control of the amount of resin in the product with 100% accuracy and reliability.

Each blade is independently milled by CNC and the folding process is completed using an exclusive thermo-forming system with a controlled tempering of the material.

This system delivers consistency and unbeatable durability, particularly in the flexion area of the blade.

The Fiberglass blades are constructed of a material impregnated with a proprietary-formulated resin, making it especially responsive, lightweight, and high-performance. The carbon and fiberglass blended blades are compressed in a unique layering process that achieves maximum performance while reducing muscle fatigue over periods of extended use.

The new carbon blades are manufactured using a combination of varying lengths in the carbon and fiberglass layers, all of it finished with G10 resin. The new carbon used is 3k with crossed fibers woven at 90°.

Two types of blades are made in variable thickness, which facilitates high-performance parabolic curvature.

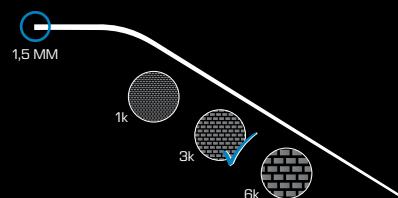
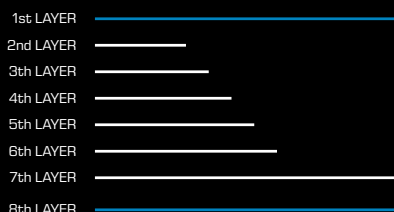

BLADE GEOMETRY

Double Wave Flex

The new freediving and deeper spearfishing blades have an optimal 30-degree angle of attack. This creates a natural extension of the leg, so that the forward thrust has the same amplitude as the return kick. Additionally, the length, width and layering of materials make it possible to achieve a double undulating stroke resulting in continuous thrust.



	X-WING CARBON	X-WING APNEA	X-WING APNEA-S	X-WING PRO	X-WING
CODE	420415	420416	42041	420420	420419
HARDNESS	SOFT	•	•		•
	MEDIUM	•	•	•	•
LENGHT	693	693	613	713	713
DOUBLE WAVE FLEX	•	•	•	•	•
MATERIAL	PP			•	•
	FIBERGLASS	•	•	•	
	CARBON	•			
USE	DEEP FREEDIVING & SPEARFISHING	•	•		
	FREEDIVING & SPEARFISHING			•	•

X-WING PRO

Code: 420420

RRP
€ 130.00



- TAPERED HIGH-QUALITY ELASTOMER BLADE FACILITATES EXCELLENT AGILITY AND PERFORMANCE
- PERFORMANCE ENGINEERED FOOT POCKET DELIVERS PERFECT POWER TRANSMISSION FROM FOOT TO BLADE
- V-TIP TO PREVENT SLIPPING FROM SIDE TO SIDE WHILE KICKING
- THE BLADE IS 190 MM WIDE AND 713 MM LONG
- 30° BLADE INCLINATION RELATIVE TO THE FOOT POCKET
- THE X-WING FOOT POCKET IS DESIGNED TO BE WORN ALSO WITHOUT NEOPRENE SOCKS
- INTERCHANGEABLE BLADE CONSTRUCTION

COLOR VARIATIONS



TECHNICAL FEATURES

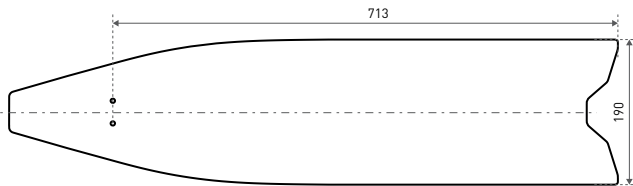

Sizes			Length	Width
EU	UK	USA		
36/37	4/4.5	4.5/5	937mm	190mm
38/39	5.5/6.5	6/7	951mm	190mm
40/41	6.5/7.5	7/8	958mm	190mm
42/43	8/9	8.5/9.5	972mm	190mm
44/45	10/10.5	10/11	991mm	190mm
46/47	11.5/12	12/13	1000mm	190mm

Blade material	Technopolymer
----------------	---------------

SPARE PARTS

X-Wing Foot Pocket	420924	Page 196
X-Wing Blade Fixing Set	420925	Page 196
X-Wing Pro Fin Blade	420923	Page 196

ACCESSORIES

Razor Fin Insole	423943	Page 208
------------------	--------	----------

X-WING

Code: 420419

RRP
€ 130.00



- TAPERED HIGH-QUALITY ELASTOMER BLADE FACILITATES EXCELLENT AGILITY AND PERFORMANCE
- PERFORMANCE ENGINEERED FOOT POCKET DELIVERS PERFECT POWER TRANSMISSION FROM FOOT TO BLADE
- V-TIP TO PREVENT SLIPPING FROM SIDE TO SIDE WHILE KICKING
- THE BLADE IS 190 MM WIDE AND 713 MM LONG
- 30° BLADE INCLINATION RELATIVE TO THE FOOT POCKET
- 30% SOFTER BLADE VERSUS RAZOR PRO FINS
- BEST CHOICE FOR EXTENDED SURFACE SWIMMING
- INTERCHANGEABLE BLADE CONSTRUCTION
- THE X-WING FOOT POCKET IS DESIGNED TO BE WORN ALSO WITHOUT NEOPRENE SOCKS

TECHNICAL FEATURES

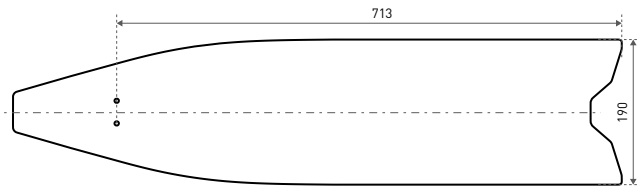

Sizes			Length	Width
EU	UK	USA		
36/37	4/4.5	4.5/5	937mm	190mm
38/39	5.5/6.5	6/7	951mm	190mm
40/41	6.5/7.5	7/8	958mm	190mm
42/43	8/9	8.5/9.5	972mm	190mm
44/45	10/10.5	10/11	991mm	190mm
46/47	11.5/12	12/13	1000mm	190mm

Blade material	Technopolymer
----------------	---------------

SPARE PARTS

X-Wing Foot Pocket	420924	Page 196
X-Wing Blade Fixing Set	420925	Page 196
X-Wing Fin Blade	420922	Page 196

ACCESSORIES

Razor Fin Insole	423943	Page 208
------------------	--------	----------

RAZOR POLYGON

Code: 420418

RRP
€ 345.00



- BLADE PRODUCED WITH PRE-IMPREGNATED FIBERGLASS LAYERS
- CONSTANT BLADE THICKNESS
- INDIGO BASED CAMOUFLAGE DISGUISES THE SPEARFISHER FOR OPTIMAL FISHING POTENTIAL
- THE BLADE IS 22 CM WIDE AND 59 CM LONG
- HIGH-QUALITY MANUFACTURING PROCESS
- VARIABLE SIDE RIBS SUPPORT AND OPTIMIZE CHANNEL THRUST AND FLEX
- 26° BLADE INCLINATION RELATIVE TO THE FOOT POCKET
- THE RAZOR FOOT POCKET IS DESIGNED TO BE WORN WITH A 3 MM NEOPRENE SOCK
- INTERCHANGEABLE BLADE CONSTRUCTION

TECHNICAL FEATURES



Sizes			Length	Width
EU	UK	USA		
39/40	5.5/6.5	7/8	843mm	220mm
41/42	7.5/8	8.5/9.5	853mm	220mm
43/44	9/10	10/11	873mm	220mm
45/46	10.5/11.5	12/13	883mm	220mm
47/48	12/13	13/14	893mm	220mm

Blade material	Carbon and Fiberglass
----------------	-----------------------

SPARE PARTS

Razor Foot Pocket	420904	Page 208
Razor Polygon Fin Blade	420921	Page 208

ACCESSORIES

Razor Fin Insole	423943	Page 208
------------------	--------	----------



RAZOR MATRIX

Code: 420409 SFT/MED

RRP
€ 389.00



- BLADE PRODUCED WITH PRE-IMPREGNATED CARBON AND FIBERGLASS LAYERS
- 3K CARBON WITH FIBERS WOVEN AT 90°
- FIBERS CROSS OVER EACH OTHER FEWER TIMES, INCREASING THE RESPONSIVENESS OF THE BLADE
- VARIABLE BLADE THICKNESS AND HIGH-PERFORMING PARABOLIC FLEXION
- THE BLADE IS 20.5CM WIDE AND 65CM LONG
- HIGH-QUALITY MANUFACTURING PROCESS
- VARIABLE SIDE RIBS SUPPORT AND OPTIMIZE CHANNEL THRUST AND FLEX
- AVAILABLE WITH A SOFT OR MEDIUM STRENGTH BLADE
- 22° BLADE INCLINATION RELATIVE TO THE FOOT POCKET
- THE RAZOR FOOT POCKET IS DESIGNED TO BE WORN WITH A 3 MM NEOPRENE SOCK
- FIN PROTECTION BAG INCLUDED

TECHNICAL FEATURES

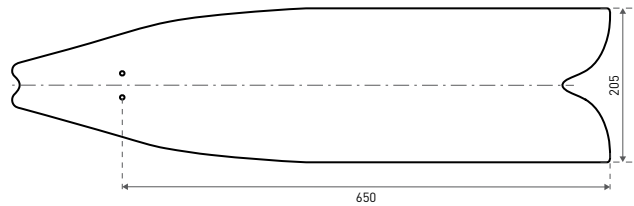

Sizes			Length
EU	UK	USA	
39/40	5.5/6.5	7/8	900mm
41/42	7.5/8	8.5/9.5	910mm
43/44	9/10	10/11	930mm
45/46	10.5/11.5	12/13	940mm
47/48	12/13	13/14	950mm

Blade material	Carbon and Fiberglass
----------------	-----------------------

SPARE PARTS

Razor Foot Pocket	420904	Page 208
Razor Matrix Fin Blade	420911	Page 208

ACCESSORIES

Razor Fin Insole	423943	Page 208
------------------	--------	----------

RAZOR PRO

Code: **420401**

RRP
€ 112.00

- INTERCHANGEABLE BLADE TO MEET DEMANDS IN ALL DIVING CONDITIONS
- TAPERED HIGH-QUALITY ELASTOMER BLADE FACILITATES EXCELLENT AGILITY AND PERFORMANCE
- DESIGNED TO BE WORN WITH A 3MM NEOPRENE SOCK
- PERFORMANCE ENGINEERED FOOT POCKET DELIVERS PERFECT POWER TRANSMISSION FROM FOOT TO BLADE
- V-TIP TO PREVENT SLIPPING FROM SIDE TO SIDE WHILE KICKING



TECHNICAL FEATURES

Sizes			Length
EU	UK	USA	
39/40	5.5/6.5	7/8	870mm
41/42	7.5/8	8.5/9.5	880mm
43/44	9/10	10/11	900mm
45/46	10.5/11.5	12/13	910mm
47/48	12/13	13/14	920mm

Blade material	Technopolymer
----------------	---------------

SPARE PARTS

Razor Foot Pocket	420904	Page 208
Razor Pro Black Fin Blade	420901	Page 208

ACCESSORIES

Razor Fin Insole	423943	Page 208
------------------	--------	----------

RAZOR

Code: **420402**

RRP
€ 112.00

- IDEAL CHOICE FOR SHALLOW TO MID-DEPTH DIVING
- 30% SOFTER BLADE VERSUS RAZOR PRO
- BEST CHOICE FOR EXTENDED SURFACE SWIMMING
- DESIGNED TO BE WORN WITH A 3MM NEOPRENE SOCK
- INTERCHANGEABLE BLADE CONSTRUCTION



TECHNICAL FEATURES

Sizes			Length
EU	UK	USA	
39/40	5.5/6.5	7/8	870mm
41/42	7.5/8	8.5/9.5	880mm
43/44	9/10	10/11	900mm
45/46	10.5/11.5	12/13	910mm
47/48	12/13	13/14	920mm

Blade material	Technopolymer
----------------	---------------

SPARE PARTS

Razor Foot Pocket	420904	Page 208
Razor Grey Fin Blade	420902	Page 208

ACCESSORIES

Razor Fin Insole	423943	Page 208
------------------	--------	----------

RAZOR FIN BLADES

RAZOR BLADES

Code: 420911 ◊ SFT/MED

RRP
€ 179.00

RAZOR POLYGON FIN BLADE

Code: 420921

RRP
€ 159.00

RAZOR PRO BLACK FIN BLADE

Code: 420901

RRP
€ 29.00

RAZOR GREY FIN BLADE

Code: 420902

RRP
€ 29.00

- PACK INFO: SOLD SINGLY



RAZOR FOOT POCKET

Code: 420904

RRP
€ 42.00

- DESIGNED TO BE WORN WITH A 3 mm NEOPRENE SOCK
- WEARING THESE FINS BAREFOOT, USE THE NEXT SIZE SMALLER FINS
- PACK INFO: SOLD SINGLY



TECHNICAL FEATURES

Sizes	39/40 - 41/42 - 43/44 - 45/46 - 47/48
-------	---------------------------------------

RAZOR BLADE FIXING SET

Code: 420925

RRP
€ 7.00

- BLADE ATTACHMENT KIT FOR YOUR MARES RAZOR/RAZOR PRO FINS
- REPLACE PARTS
- PACK INFO: SOLD SINGLY



RAZOR FIN INSOLE

Code: 423943

RRP
€ 6.50

- PREFORMED INSOLE CAN MAKE A RAZOR FOOT POCKET ONE SIZE SMALLER
- USE SCISSORS TO CUT ALONG THE LINES PROVIDED ON THE UNDERSIDE
- THE LENGTH CAN BE ADJUSTED TO THREE DIFFERENT SIZES
- PACK 5 PCS



SIZES

	A	+EU 39/40	=EU 37/38	=UK 4.5/5	=USA 5/6
	B	+EU 41/42	=EU 40/41	=UK 6.5/7.5	=USA 7/8
	C	+EU 43/44	=EU 42/43	=UK 8/9	=USA 8.5/9.5
	C	+EU 45/46	=EU 44/45	=UK 10/10.5	=USA 10/11

AVANTI QUATTRO POWER

Code: 420404

RRP
€ 112.00

- MARES CHANNEL THRUST PATENT
- OPTIMIZED WATER CHANNELING FOR SIGNIFICANT FLOW AND THRUST
- SHORTER BLADE FOR INCREASED CONTROL AND FAST MANEUVERS IN AND UNDER WATER
- ANATOMIC FOOT POCKET WITH REINFORCED HEEL



CONCORDE

Code: 420406

RRP
€ 79.00

- IDEAL CHOICE FOR SHALLOW TO MID-DEPTH DIVING
- TECHNOPOLYMER BLADE AND HIGH-PERFORMANCE PARABOLIC FLEXION
- OVER MOLDED FOOT POCKET
- TAPERED LATERAL RIPS FOR PROGRESSIVE BLADE FLEX
- TIP PROFILE PREVENTS SLIPPING FROM SIDE TO SIDE WHILE KICKING



COLOR VARIATIONS



BK

GN

TECHNICAL FEATURES

Sizes			Length
EU	UK	USA	
40/41	6.5/7.5	7/8	710mm
42/43	8/9	8.5/9.5	725mm
44/45	10/10.5	10/11	755mm
46/47	11.5/12	12/13	765mm

Blade material	EVA
----------------	-----

TECHNICAL FEATURES

Sizes			Length
EU	UK	USA	
38/39	5/6	6/7	860mm
40/41	6.5/7.5	7/8	874mm
42/43	8/9	8.5/9.5	889mm
44/45	10/10.5	10/11	902mm
46/47	11.5/12	12/13	916mm

Blade material	Technopolymer
----------------	---------------

TECHNICAL SPECIFICATIONS



			X-Wing Carbon	X-Wing Apnea	X-Wing Apnea S	X-Wing Pro	X-Wing
Code			420415	420416	420417	420420	420419
Color						● BK ● BWN	● BL
Sizes							
EU	UK	USA					
38/39	5/6	6/7	931mm	931mm	851mm	951mm	951mm
39/40	5.5/6.5	7/8					
40/41	6.5/7.5	7/8	938mm	938mm	858mm	958mm	958mm
41/42	7.5/8	8.5/9.5					
42/43	8/9	8.5/9.5	952mm	952mm	872mm	972mm	972mm
43/44	9/10	10/11					
44/45	10/10.5	10/11	971mm	971mm	891mm	991mm	991mm
45/46	10.5/11.5	12/13					
46/47	11.5/12	12/13	980mm	980mm	900mm	1000mm	1000mm
47/48	12/13	14/15					
RRP			€ 6,285	€ 5,835	€ 5,835	€ 1,950	€ 1,950



			Razor Polygon	Razor Matrix	Razor Pro	Razor	Avanti Quattro Power	Concorde
Code			420418	420409 SFT/MED	420401	420402	420404	420406
Color			● CM		● BK	● GR	● CM	● BK ● GN
Sizes								
EU	UK	USA						
38/39	5/6	6/7						904g - 860mm
39/40	5.5/6.5	7/8	1027g - 843mm	962g - 900mm	1035g - 870mm	1028g - 870mm		
40/41	6.5/7.5	7/8					960g - 710mm	932g - 874mm
41/42	7.5/8	8.5/9.5	1080g - 853mm	1015g - 910mm	1095g - 880mm	1028g - 880mm		
42/43	8/9	8.5/9.5					1053g - 725mm	968g - 889mm
43/44	9/10	10/11	1130g - 873mm	1065g - 930mm	1145g - 900mm	1028g - 900mm		
44/45	10/10.5	10/11					1175g - 755mm	1002g - 902mm
45/46	10.5/11.5	12/13	1195g - 883mm	1130g - 940mm	1210g - 910mm	1028g - 910mm		
46/47	11.5/12	12/13					1210g - 765mm	1027g - 916mm
47/48	12/13	14/15	1235g - 893mm	1170g - 950mm	1250g - 920mm	1028g - 920mm		
RRP			€ 5,175	€ 5,835	€ 1,680	€ 1,680	€ 1,680	€ 1,185



mares
pure passion

2022

MASKS & SNORKELS

◇ Please note that some sizes/colors are only available while stocks last

X-TREAM

Code: 421417

RRP
€ 69.00



- OVER MOLDED FRAME AND ANATOMICAL SKIRT
- MINIMUM DISTANCE BETWEEN THE LENS AND EYES
- ULTRA-MINIMAL INTERNAL VOLUME
- INCREASED FIELD OF VISION
- VERY LIGHTWEIGHT
- ANTI-REFLECTIVE PROPERTIES
- HYDRODYNAMIC PROFILE REDUCES DRAG IN THE WATER
- ERGONOMIC MASK STRAP BUCKLES FOR BETTER HYDRODYNAMICS
- ERGONOMIC MASK STRAP SNORKEL RETAINER FOR EASY DONNING
- EMBOSSED GRIP AREA ON THE NOSE FOR THE PERFECT FIT WITH A NOSE CLIP
- SILICONE USED IN THE SKIRT REDUCES FOGGING



COLOR VARIATIONS



BKBK

GNBL

BLWH

DETAILS



VIPER

Code: **421411**

RRP
€ 57.00



- REDUCED DISTANCE FROM LENS TO EYE
- MINIMAL INTERNAL VOLUME
- INCREASED FIELD OF VISION
- ANATOMICAL SKIRT WITHOUT INTERNAL LIP
- VERY LIGHTWEIGHT
- MATTE FINISH FOR ANTI-REFLECTIVE PROPERTIES
- HYDRODYNAMIC PROFILE REDUCING RESISTANCE IN WATER
- ERGONOMIC MASK STRAP BUCKLES FOR EFFORTLESS OPERATION
- THE SILICONE USED IN SKIRT REDUCES FOGGING



COLOR VARIATIONS



BK BK

BWN BK

GN BK

BL BL

SPYDER

Code: **421415**

RRP
€ 59.00



- REDUCED DISTANCE FROM LENS TO EYE
- MINIMAL INTERNAL VOLUME
- INCREASED FIELD OF VISION
- ANATOMICAL SKIRT
- VERY LIGHTWEIGHT
- MATTE FINISH WITH ANTI-REFLECTIVE PROPERTIES
- HYDRODYNAMIC SPYDER PROFILE REDUCES RESISTANCE IN WATER
- ERGONOMIC MASK STRAP BUCKLES FOR EFFORTLESS OPERATION
- THE SILICONE USED IN THE SKIRT REDUCES FOGGING



COLOR VARIATIONS



BK BK

BW GN

BK BL

BW BK

NEW

STAR LIQUIDSKIN

Code: 421400

RRP
€ 65.00

- BI-SILICONE SKIRT AND STRAP, EXCLUSIVE MARES LIQUIDSKIN © PATENT
- MINIMAL INTERNAL VOLUME
- REDUCED DISTANCE FROM LENS TO EYE
- INCREASED FIELD OF VISION
- LOW PROFILE BUCKLES POSITIONED ON THE SKIRT



COLOR VARIATIONS



BKGR

BKAG

ACCESSORIES

OPTICAL LENS

Code: 411191 / from -1,0 to -5,0

RRP
€ 49.00

STAR

Code: 421402

RRP
€ 44.00

- MINIMAL INTERNAL VOLUME
- REDUCED DISTANCE FROM LENS TO EYE
- INCREASED FIELD OF VISION
- LOW PROFILE BUCKLES POSITIONED ON THE SKIRT



COLOR VARIATIONS



BKBK

CMBK

ACCESSORIES

OPTICAL LENS

Code: 411191 / from -1,0 to -5,0

RRP
€ 49.00

SAMURAI X

Code: 421413

RRP
€ 49.00



- RESTYLING DELLA STORICA MASCHERA SAMURAI
- DISTANZA RIDOTTA TRA LENTI E OCCHI
- VOLUME INTERNO MINIMO INFERIORE A 80 CM3
- AMPIO CAMPO VISIVO
- NUOVO TELAIO SOTTILE E LEGGERISSIMO
- FINITURA OPACA CON PROPRIETÀ ANTI RIFLESSO
- FIBBIE SUL FACCIALE



COLOR VARIATIONS



BKBK

BWNBK

GNBK

SEALHOUETTE

Code: 421414

RRP
€ 62.00



- BI-LENS MASK
- SILICONE SKIRT
- REDUCED DISTANCE BETWEEN LENSES AND EYES
- AMPLE FIELD OF VISION
- LIGHTWEIGHT
- SOFT TOUCH SILICONE BUCKLES
- BUCKLES ON SKIRT



COLOR VARIATIONS



BKBK

MBKBK

MBLBK

*Our optical lenses conform to norm EN 16805. They are not medical devices.

DUAL CAMO

Code: 421457

RRP
€ 25.00

- TUBE IS MADE IN SOFT PVC IN A BLACK CAMOUFLAGE DESIGN
- ANATOMICAL MOUTHPIECE IN HYPOALLERGENIC SILICONE
- DIAMETER AND LENGTH OF TUBE ARE OPTIMIZED FOR EASIER CLEARING AND TO AVOID AIR TURBULENCE
- SPECIAL "D" SHAPED BARREL DESIGN ELIMINATES DISCOMFORT IN THE AREA OF THE TEMPLE



COLOR VARIATIONS



MBKSA

DUAL BASIC

Code: 421455

RRP
€ 18.00

- IDEAL FOR PROLONGED USE
- ANATOMICAL MOUTHPIECE IN HYPOALLERGENIC SILICONE
- DIAMETER AND LENGTH OF TUBE ARE OPTIMIZED FOR EASIER CLEARING AND TO AVOID AIR TURBULENCE
- SPECIAL "D" SHAPED BARREL DESIGN ELIMINATES DISCOMFORT IN THE AREA OF THE TEMPLE



COLOR VARIATIONS



BKSA CLSA BLSA

DUAL

Code: 421454

RRP
€ 22.00

- TUBE IS MADE FROM TWO MATERIALS WITH TWO DIFFERENT SOFTNESS LEVELS
- IDEAL FOR PROLONGED USE
- ANATOMICAL MOUTHPIECE IN HYPOALLERGENIC SILICONE
- DIAMETER AND LENGTH OF TUBE ARE OPTIMIZED FOR EASIER CLEARING AND TO AVOID AIR TURBULENCE
- SPECIAL "D" SHAPED BARREL DESIGN ELIMINATES DISCOMFORT IN THE AREA OF THE TEMPLE



COLOR VARIATIONS



BKSA BWNSA GNSA

ELEMENT

Code: 421456

RRP
€ 11.00

- SOFT TUBE
- DIAMETER AND LENGTH OF TUBE ARE OPTIMIZED FOR NATURAL EFFORTLESS BREATHING
- HYPOALLERGENIC SILICONE MOUTHPIECE



COLOR VARIATIONS



BKSA BWNSA

ELEMENT FLOATING

NEW

Code: 421458

RRP
€ 15.00

- FLOATS IN FRESH AND SALT WATER. NEVER LOSE YOUR SNORKEL AGAIN!
- SOFT TUBE
- THE DIAMETER AND LENGTH OF THE SNORKEL ARE OPTIMIZED FOR NATURAL, EFFORTLES BREATHING
- HYPOALLERGENIC SILICONE MOUTHPIECE



COLOR VARIATIONS



Mask	X-Tream	Viper	Spyder	Star Liquidskin	Star	Samurai X	Sealhouette
Code	421417	421411	421415	421400	421402	421413	421414
Colors	<ul style="list-style-type: none"> ● BKBK ● BLWH ● GNBL 	<ul style="list-style-type: none"> ● BKBK ● BLBL ● BWNBK ● GNBK 	<ul style="list-style-type: none"> ● BKBBL ● BKKBK ● BWKBW ● BWKGN 	<ul style="list-style-type: none"> ● BKAG ● BKGR 	<ul style="list-style-type: none"> ● BKBK ● CMBK 	<ul style="list-style-type: none"> ● BKBK ● BWNBK ● GNBK 	<ul style="list-style-type: none"> ● BKBK ● MBKBK
Optical lens (optional)				411191 from -1 to -5	411191 from -1 to -5		
Streamlined profile		■					
Light weight	■	■	■			■	
Wide field of vision	■	■	■			■	■
Internal volume	Minimal Reduced	■	■	■	■	■	■
RRP	€ 69.00	€ 57.00	€ 59.00	€ 65.00	€ 44.00	€ 49.00	€ 62.00



mares

2022

NEOPRENE

POLYGON

30	
	RRP
Code Jacket: 422304	€ 165.00
Code Pants: 422305	€ 115.00

50	
	RRP
Code Jacket: 422306	€ 185.00
Code Pants : 422307	€ 139.00

80/65	
	RRP
Code Jacket: 422308	€ 215.00
Code Pants: 422309	€ 169.00



- INDIGO POLYGON-BASED CAMOUFLAGE DISGUISES THE SHAPE OF THE SPEARFISHER
 - A PREFORMED CUT ENSURES COMFORT AND EXCELLENT FIT
 - COMPRESSION RESISTANT OPEN CELL MATERIAL WITH EXCELLENT ELASTICITY AND GREAT THERMAL PROPERTIES
 - STITCHED FINISHING AROUND THE FACE, WAIST, WRISTS AND ANKLES
 - ANTI-SLIP CHEST PAD WITH A NEOPRENE "SHOCK ABSORBER" INSIDE
 - NEW CHIN DESIGN
 - BEAVERTAIL WITH VELCRO® BRAND CLOSURE FOR PERFECT ADJUSTMENT
 - ANTI-SLIP KNEE PAD
- 422308 JACKET - DIFFERENTIATED THICKNESS:
8MM ON THE CHEST AND ARMS, 6,5MM ON THE FOREARMS AND HOOD
 - 422309 PANTS - 6,5MM



TECHNICAL FEATURES

Thickness	3mm / 5mm / 8-6,5mm				
Fabric Type	Lining				
	Neoprene				
	Open cell				
Sizes	2	3	4	5	6

DETAILS



Three-material waistband to impede water entry

Softer border with folded smooth neoprene



POLYGON

mares

The latest research regarding fish vision shows that they are capable of seeing ultraviolet rays which are invisible to the human eye. Contrasting colors are also more visible to them. We can obtain the best camouflage by reducing the contrast between colors with a polygonal design that changes with distance, but the most innovative feature of this material is its ultraviolet absorption.

UV light is especially dominant on cloudy or grey days, and makes fluorescent materials brighter. The least reflective, UV ray absorbing color is INDIGO, the base for our new camouflage.

• COLOR CONTRAST REDUCTION WITH DISTANCE

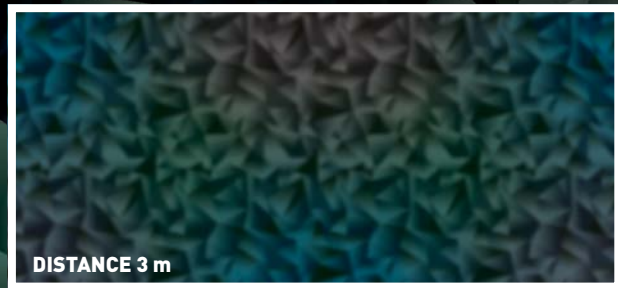

• UV COLOR ABSORPTION AS PERCEIVED BY FISH

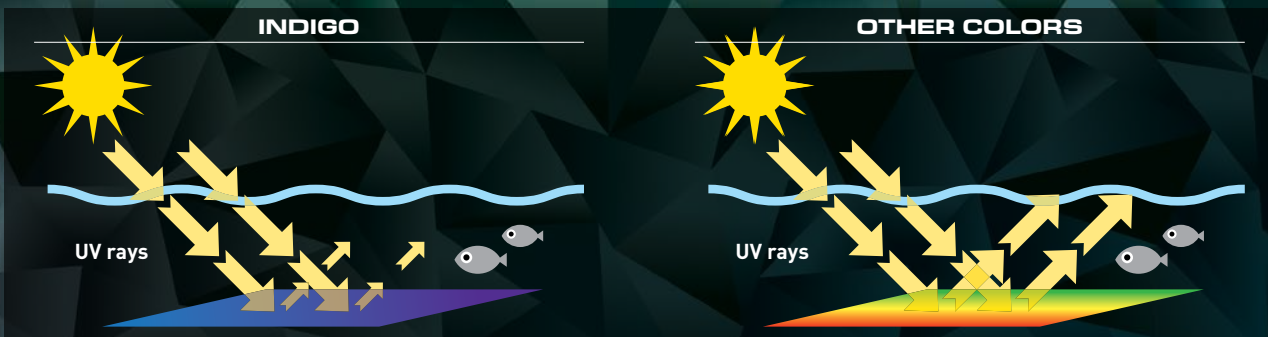

POLYGON BLACK

NEW

Code: **422320** - Jacket

RRP
€ 165.00

Code: **422321** - Pants

RRP
€ 125.00



- BLACK POLYGON CAMOUFLAGE WITH INDIGO BASED PANELS DISGUISE THE SHAPE OF THE SPEARFISHER
- A PREFORMED CUT ENSURES COMFORT AND AN EXCELLENT FIT
- MADE IN AN OPEN CELL MATERIAL WHICH OFFERS EXCELLENT ELASTICITY, GOOD THERMAL PROPERTIES AND IS COMPRESSION RESISTANT
- ANTI-SLIP CHEST PAD WITH A 6MM NEOPRENE "SHOCK ABSORBER" INSIDE
- NEW CHIN DESIGN
- NEW VELCRO® BRAND CLOSURE FOR PERFECT SUIT ADJUSTMENT



TECHNICAL FEATURES

Thickness	5mm				
Fabric Type	Lining				
	Neoprene				
	Open cell				
Sizes	2	3	4	5	6

DETAILS



Velcro beavertail closure for perfect adjustment

6 mm chest pad

MERGE

Code: **422310** - Jacket

RRP
€ 249.00

Code: **422311** - Pants

RRP
€ 199.00



- NEW FAST-DRYING THREE-MATERIAL DESIGN - ELASTIC FABRIC BETWEEN TWO NEOPRENE LAYERS
- SMOOTH / OPEN CELL INNER FABRIC OFFERS HIGH RESISTANCE
- NEOPRENE OFFERS THERMAL, ELASTIC AND HYDRODYNAMIC BENEFITS FOR THE HEAD AND SHOULDERS DURING DIVING AND THE LEGS DURING SURFACE SWIMMING
- A PREFORMED CUT ENSURES COMFORT AND EXCELLENT FIT
- NEW CHIN DESIGN
- NEW MATERIAL DISTRIBUTION FOR EASY BREATHING
- NEW BEAVERTAIL WITH VELCRO® BRAND CLOSURE FOR PERFECT ADJUSTMENT
- BLACK/INDIGO POLYGON-BASED CAMOUFLAGE DISGUISES THE SHAPE OF THE SPEARFISHER
- SOFT NEOPRENE FINISH AROUND THE FACE, WRISTS AND ANKLES
- ANTI-SLIP CHEST PAD WITH A NEOPRENE "SHOCK ABSORBER" AND KNEE PADS
- PANTS WITH THREE-MATERIAL WAISTBAND TO IMPEDE WATER ENTRY
- PANTS WITH AN ULTRA-STRETCH ABDOMINAL BAND TO FACILITATE BREATHING



TECHNICAL FEATURES

Thickness	5mm				
Fabric Type	Smooth				
	Stretch Fabric				
	Open cell				
Sizes	2	3	4	5	6

DETAILS



Velcro beavertail closure for perfect adjustment



Three-material waistband to impede water entry

EXPLORER CAMO BLACK

30	
	RRP
Code Jacket: 422040	€ 155.00
Code Pants: 422041	€ 110.00

50	
	RRP
Code Jacket: 422038	€ 175.00
Code Pants: 422039	€ 125.00

70	
	RRP
Code Jacket: 422037	€ 185.00



- BLACK CAMOUFLAGE PRINTED ON A GREY LINING HELPS TO DISGUISE THE SPEARFISHER
- A PREFORMED CUT ENSURES COMFORT AND EXCELLENT FIT
- EXCELLENT ELASTICITY AND COMPRESSION RESISTANCE
- ANTI-SLIP CHEST PAD AND NEOPRENE "SHOCK ABSORBER" INSIDE
- REINFORCED KNEE PADS



TECHNICAL FEATURES

Thickness	3mm / 5mm / 7mm				
	Lining				
Fabric Type	Neoprene				
	Open cell				
Sizes	2	3	4	5	6

DETAILS



Quick connect, beaver tail closure



Reinforced knee pads

ILLUSION BWN

30	
	RRP
Code Jacket: 422035	€ 159.00
Code Pants: 422036	€ 110.00

50	
	RRP
Code Jacket: 422033	€ 170.00
Code Jacket: 422034	€ 130.00

70	
	RRP
Code Jacket: 422032	€ 195.00



- OCEAN FLOOR CAMOUFLAGE PRINTED ON A BEIGE LINING MASKS THE DIVER
- A PREFORMED CUT ENSURES COMFORT AND EXCELLENT FIT
- EXCELLENT ELASTICITY AND COMPRESSION RESISTANCE
- ANTI-SLIP CHEST PAD AND NEOPRENE "SHOCK ABSORBER" INSIDE
- REINFORCED KNEE PADS



TECHNICAL FEATURES

Thickness	3mm / 5mm / 7mm					
Fabric Type	Lining					
	Neoprene					
	Open cell					
Sizes	2	3	4	5	6	

ILLUSION

30	
	RRP
Code Jacket: 422487	€ 159.00
Code Jacket: 422488	€ 105.00

50	
	RRP
Code Jacket: 422484	€ 165.00
Code Jacket: 422485	€ 130.00
Code Jacket: 422486	€ 159.00



- OCEAN FLOOR CAMOUFLAGE PRINTED ON BEIGE LINING CREATE TOTAL CONCEALMENT FOR THE DIVER
- PREFORMED CUT ENSURES COMFORT AND EXCELLENT FIT
- EXCELLENT ELASTICITY AND COMPRESSION RESISTANCE
- ANTI-SLIP CHEST PAD AND NEOPRENE "SHOCK ABSORBER" INSIDE
- REINFORCED KNEE PADS



TECHNICAL FEATURES

Thickness	3mm / 5mm					
Fabric Type	Lining					
	Neoprene					
	Open cell					
Sizes	2	3	4	5	6	

EXPLORER

30	
	RRP
Code Jacket: 422479	€ 119.00
Code Pants: 422480	€ 84.00

50	
	RRP
Code Jacket: 22456	€ 135.00
Code Pants: 422457	€ 105.00
Code Long John: 422458	€ 125.00



- PREFORMED CUT ENSURES COMFORT AND EXCELLENT FIT
- EXCELLENT ELASTICITY AND COMPRESSION RESISTANCE
- ANTI-SLIP CHEST PAD AND NEOPRENE "SHOCK ABSORBER" INSIDE
- REINFORCED KNEE PADS



TECHNICAL FEATURES

Thickness	3mm / 5mm					
	Lining					
Fabric Type	Neoprene					
	Open cell					
Sizes	2	3	4	5	6	

EXPLORER SPORT

30	
	RRP
Code Jacket: 422312	€ 119.00
Code Pantalon: 422313	€ 95.00

50	
	RRP
Code Jacket: 422466	€ 139.00
Code Long John: 422467	€ 129.00





- A PREFORMED CUT ENSURES COMFORT AND EXCELLENT FIT
- ELASTICITY, COMFORTABLE, COMPRESSION RESISTANT AND EASY TO WEAR
- ANTI-SLIP CHEST PAD AND NEOPRENE "SHOCK ABSORBER" INSIDE
- REINFORCED KNEE PADS



TECHNICAL FEATURES

Thickness	5mm / 3mm					
	Lining					
Fabric Type	Neoprene					
	Lining					
Sizes	2	3	4	5	6	

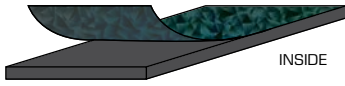
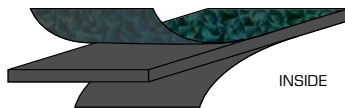
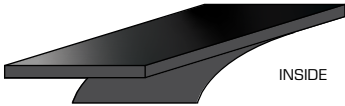
NEOPRENE

	DESCRIPTION	USE	WETSUIT NAME	THICKNESS
LINED/OPEN CELL 	Fit is snug to the skin for greater comfort. Lubricant required for donning.	SPEARFISHING	POLYGON	3 / 5 / 8 -6.5 mm
		SPEARFISHING	POLYGON BLACK	5 mm
		SPEARFISHING	EXPLORER CAMO BLACK	3 / 5 / 7 mm
		SPEARFISHING	ILLUSION BWN	3 / 5 / 7 mm
		SPEARFISHING	ILLUSION	3 / 5 mm
		SPEARFISHING	EXPLORER	3 / 5 mm
		FREEDIVING	APNEA INSTINCT	5 mm
LINED/LINED 	Exceptionally durable and easy to put on.	SPEARFISHING	EXPLORER SPORT	3 / 5 mm
SMOOTH/LINED 	Quick-Dry exterior, highly elastic and hydrodynamic.	FREEDIVING	PRISM SKIN	3 / 5 mm
		FREEDIVING / POOL	HORIZON	2 mm
POLYURETHANE/LINED 	Extremely hydrodynamic, elastic, and durable.	FREEDIVING / POOL	HORIZON	0.5 mm
TWINPLY 	As durable as nylon lining, but with the advantages of a smooth exterior and open-cell on the skin.	SPEARFISHING	MERGE	5 mm

ADDITIONAL FEATURES

WETSUIT NAME	1 / CLOSURE TYPE	2 / CHEST REINFORCEMENT	3 / SOFT SEALS
POLYGON	VELCRO	YES	YES (5 / 8 -6.5 mm ONLY)
POLYGON BLACK	VELCRO	YES	NO
MERGE	VELCRO	YES	YES
EXPLORER CAMO BLACK	ALAMARO (2)	YES	NO
ILLUSION BWN	ALAMARO (2)	YES	NO
ILLUSION	ALAMARO (2)	YES	NO
EXPLORER	ALAMARO (1)	YES	NO
EXPLORER SPORT	ALAMARO (1)	YES	NO
APNEA INSTINCT	ALAMARO (1)	NO	YES (FACE ONLY*)
PRISM SKIN	VELCRO	NO	YES (5mm ONLY)
HORIZON	BACK ZIP	NO	NO

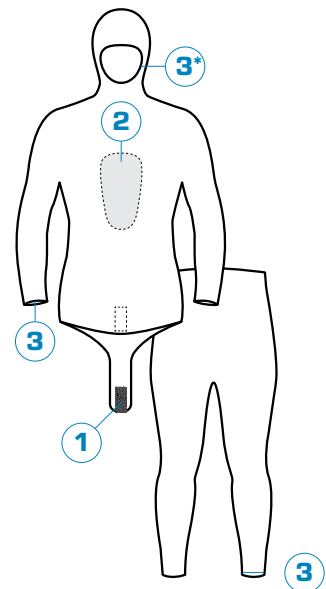

PRISM SKIN

NEW

50	
	RRP
Code Jacket: 422322	€ 199.00
Code Pants: 422323	€ 149.00
Code Jacket Lady: 422324	€ 199.00
Code Pants Lady: 422325	€ 149.00



- ULTRASTRETCH SMOOTH-SKIN MATERIAL FOR EASY BREATHING
- INSIDE LINING ALLOWS FOR EASY DONNING, PROVIDING EXCELLENT ELASTICITY AND COMPRESSION RESISTANCE
- VERY HYDRODYNAMIC MATERIAL FOR FASTER ASCENT/DESCENT
- A PREFORMED CUT ENSURES COMFORT AND EXCELLENT FIT
- SOFT BORDER HEM AROUND THE FACE, WRISTS AND ANKLES
- NEW MAN PANTS DESIGN FOR EASY BREATHING
- NEW LADY JACKET DESIGN
- NEW CHIN DESIGN
- VELCRO® BRAND CLOSURE FOR PERFECT ADJUSTMENT



TECHNICAL FEATURES

Thickness	5.0 mm				
Fabric type	Smooth				
	Neoprene				
	Colored lining				
Man Sizes	2	3	4	5	6
Lady Sizes	1	2	3	4	5

DETAILS



Soft seats

Cut dedicated to female freedivers

PRISM SKIN

30	
	RRP
Code Jacket: 422314	€ 179.00
Code Pants: 422315	€ 129.00
Code Jacket Lady: 422318	€ 179.00
Code Pants Lady: 422319	€ 129.00

- ULTRASTRETCH SMOOTH-SKIN MATERIAL FOR EASY BREATHING
 - INSIDE LINING ALLOWS FOR EASY DONNING, PROVIDING EXCELLENT ELASTICITY AND COMPRESSION RESISTANCE
 - VERY HYDRODYNAMIC MATERIAL FOR FASTER ASCENT/DESCENT
 - A PREFORMED CUT ENSURES COMFORT AND EXCELLENT FIT
 - SOFT BORDER FINISHING ON FACE, WRISTS AND ANKLES
 - NEW MAN PANTS DESIGN FOR EASY BREATHING
 - NEW LADY JACKET DESIGN
 - NEW CHIN DESIGN
 - VELCRO® BRAND CLOSURE FOR PERFECT ADJUSTMENT
- 5MM VERSION INCLUDES A SOFT BORDER HEM AROUND THE FACE, WRISTS AND ANKLES



TECHNICAL FEATURES

Thickness	3.0 mm					
Fabric type	Smooth					
	Neoprene					
	Colored lining					
Man Sizes		2	3	4	5	6
Lady Sizes	1	2	3	4	5	

DETAILS

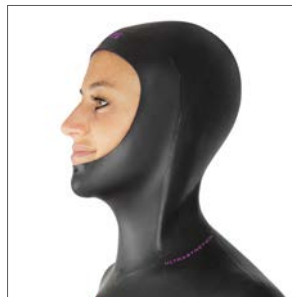

New preformed chin

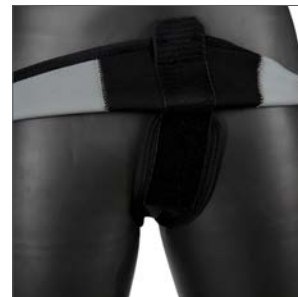

Velcro beavertail closure for perfect adjustment

HORIZON 0.5

NEW

Code: 422326

RRP
€ 139.00



- UNISEX
- MADE IN 0.5MM ULTRASTRETCH POLYURETHANE
- INNER LINING FACILITATES DONNING AND PROVIDES EXCELLENT ELASTICITY
- VERY HYDRODINAMIC MATERIAL FOR FASTER SWIMMING AND DYN FREEDIVING COMPETITIONS
- A PREFORMED CUT ENSURES COMFORT AND EXCELLENT FIT



TECHNICAL FEATURES

Thickness	0.5 mm					
Fabric type	Polyurethane					
Unisex Sizes	1	2	3	4	5	6

HORIZON 2.0

Code: 422316 - Man

Code: 422317 - Lady

RRP
€ 235.00



- ULTRA-STRETCH 2MM SMOOTH MATERIAL FOR EASY BREATHING
- INSIDE LINING ALLOWS FOR EASY DONNING, PROVIDING EXCELLENT ELASTICITY AND COMPRESSION RESISTANCE
- VERY HYDRODYNAMIC MATERIAL FOR FASTER SWIMMING
- A PREFORMED CUT ENSURES COMFORT AND EXCELLENT FIT
- NEW WATER-BARRIER NECK DESIGN



TECHNICAL FEATURES

Thickness	2.0 mm					
Fabric type	Smooth					
	Neoprene					
	Black lining					
Man Sizes		2	3	4	5	6
Lady Sizes	1	2	3	4	5	

DETAILS



New water-barrier neck design



Back zip

APNEA INSTINCT

50	
	RRP
Code Jacket: 422459	€ 140.00
Code Pants: 422460	€ 110.00
Code Jacket Lady: 422461	€ 140.00
Code Pants Lady: 422462	€ 110.00

- PREFORMED CUT ENSURES COMFORT AND EXCELLENT FIT
- EXCELLENT ELASTICITY, HIGH THERMAL PROPERTIES AND COMPRESSION RESISTANT
- THE 5 mm JACKET UTILIZES 3.5 mm NEOPRENE AT THE WRISTS AND AROUND THE FACE, INCLUDING THE SAME APPLICATION ON THE PANTS AT THE ANKLES AND WAISTBAND
- HIGH-WAISTED PANTS
- RUGGED DOUBLE-LINED BEAVER TAIL WITH QUICK-CONNECT GROMMETS



TECHNICAL FEATURES

Thickness	5mm					
Fabric Type	Lining					
	Neoprene					
	Open cell					
Sizes Man		2	3	4	5	6
Sizes Lady	1	2	3	4	5	



UNDERSUIT

Code: 422424

RRP
€ 60.00

- LINED NEOPRENE WITH AN OPEN CELL INTERIOR



TECHNICAL FEATURES

Thickness	2mm			
Fabric Type	Neoprene			
Sizes	S	M	L	XL

GLOVES FLEX

Code: 422750 3mm

Code: 422759 2mm

RRP
€ 36.00
€ 34.00

- DOUBLE LINED ULTRASTRETCH NEOPRENE
- REINFORCED PALM AND FINGERS



TECHNICAL FEATURES

Thickness	3mm		
Fabric Type	Ultrastretch Neoprene		
Sizes	XS	M	XL

Thickness	2mm		
Sizes	XS/S	M/L	XL/XXL

BACKPACK

Code: 425861 Black

RRP
€ 49.00

Code: 425863 Illusion

RRP
€ 62.00



- ANATOMICAL MODULAR BACKPACK
- POCKETS WITH HOLES FOR STANDARD 500G OR 1KG WEIGHTS, MAXIMUM 4KG
- ELASTIC CORD FOR FASTENING TO THE BELT
- QUICK RELEASE SYSTEM



SOCKS FLEX

Code: 422656 5mm

Code: 422657 3mm

Code: 422658 2mm

RRP
€ 36.00
€ 35.00
€ 33.00

- ULTRASTRETCH NEOPRENE
- LINED EXTERIOR / OPEN CELL INTERIOR
- REINFORCED DOUBLE-LINED SOLE



TECHNICAL FEATURES

Thickness	5mm / 3mm / 2mm		
Fabric Type	Ultrastretch Neoprene		
Sizes	XS/S	M/L	XL/XXL

GLOVES SMOOTH SKIN

Code: 422755

RRP
€ 42.00



- PREFORMED CUT
- NEOPRENE WITH SMOOTH EXTERIOR, LINED INTERIOR
- REINFORCED PALM AND FINGERS



TECHNICAL FEATURES

Thickness	3.5mm			
Fabric Type	Neoprene			
Sizes	S	M	L	XL

SOCKS SMOOTH SKIN

Code: 422654

RRP
€ 36.00



- SMOOTH OUTSIDE / LINED INSIDE
- PREFORMED CUT
- REINFORCED DOUBLE-LINED SOLE



TECHNICAL FEATURES

Thickness	3mm			
Fabric Type	Neoprene			
Sizes	S	M	L	XL

GLOVES FLEX GOLD

	RRP
Code 3 mm : 422763	€ 40.00
Code 5 mm : 422762	€ 42.00



- ULTRA STRETCH EXTERNAL FABRIC / SPECIAL GOLD TREATMENT ON OPEN CELL INSIDE
- DOUBLE LINED NEOPRENE ON PALM
- REINFORCED FABRIC ON PALM AND FINGERS



TECHNICAL FEATURES

Thickness	5mm / 3mm			
Fabric Type	Ultrastretch Neoprene			
Sizes	S	M	L	XL

SOCKS FLEX GOLD

	RRP
Code 3 mm : 422660	€ 40.00
Code 5 mm : 422661	€ 42.00



- ULTRA STRETCH EXTERNAL FABRIC / SPECIAL GOLD TREATMENT ON OPEN CELL INSIDE
- DOUBLE-LINED SOLE WITH EXTERNAL FABRIC REINFORCEMENT



TECHNICAL FEATURES

Thickness	5mm / 3mm			
Fabric Type	Ultrastretch Neoprene			
Sizes	S	M	L	XL

GLOVES BLACK 25/45/55

NEW

Code: **422676**

RRP
€ 39.00

- ULTRASTRETCH FABRIC
- DOUBLE LINED NEOPRENE ON PALM
- SUPER GRIP PALM DESIGN
- DIFFERENTIATED THICKNESSES TO IMPROVE SENSITIVENESS ON THE PALM (2.5MM) AND BACK OF THE HAND (4.5MM)
- 5CM WATER STOP BAND IN 5.5MM NEOPRENE SMOOTHSKIN



TECHNICAL FEATURES

Thickness	2.5 / 4.5 / 5.5mm		
Fabric Type	Ultrastretch Neoprene		
Sizes	XS/S	M	L/XL

SOCKS BLACK 50/60

NEW

Code: **422674**

RRP
€ 38.00

- DIFFERENTIATED THICKNESS TO BLOCK WATER FLOW: 5MM LOWER PART, 6MM UPPER PART
- 7CM WATER STOP BAND IN 6MM NEOPRENE SMOOTHSKIN
- ULTRASTRETCH EXTERNAL FABRIC / INTERNAL LINED MATERIAL
- DOUBLE-LINED SOLE WITH EXTERNAL FABRIC REINFORCEMENT



TECHNICAL FEATURES

Thickness	5 mm / 6mm		
Fabric Type	Ultrastretch Neoprene		
Sizes	XS/S	M/L	XL/XXL

GLOVES POLYGON BK 20/35/50

NEW

Code: **422675**

RRP
€ 38.00

- ULTRASTRETCH FABRIC
- DOUBLE LINED NEOPRENE ON PALM
- SUPER GRIP PALM DESIGN
- DIFFERENTIATED THICKNESS TO IMPROVE SENSITIVENESS ON THE PALM (2MM) AND BACK OF THE HAND (3.5MM)
- 5CM WATER STOP BAND IN 5.0MM NEOPRENE SMOOTHSKIN
- POLYGON BLACK CAMOUFLAGE DESIGN



TECHNICAL FEATURES

Thickness	2.0 / 3.5 / 5.0mm		
Fabric Type	Ultrastretch Neoprene		
Sizes	XS/S	M	L/XL

SOCKS POLYGON BK 30/50

NEW

Code: **422673**

RRP
€ 36.00

- DIFFERENTIATED THICKNESS TO BLOCK WATER FLOW: 3MM LOWER PART, 5MM UPPER PART
- 7CM WATER STOP BAND IN 5MM NEOPRENE SMOOTHSKIN
- POLYGON BLACK CAMOUFLAGE
- ULTRASTRETCH EXTERNAL FABRIC / INTERNAL LINED MATERIAL
- DOUBLE-LINED SOLE WITH EXTERNAL FABRIC REINFORCEMENT



TECHNICAL FEATURES

Thickness	5mm / 3mm		
Fabric Type	Ultrastretch Neoprene		
Sizes	XS/S	M/L	XL/XXL

GLOVES ILLUSION 30

Code: 422760

RRP
€ 35.00

- NEOPRENE DOUBLE LINING
- REINFORCED PALM AND FINGERS



TECHNICAL FEATURES

Thickness	3mm			
Fabric Type	Neoprene			
Sizes	S	M	L	XL

GLOVES ILLUSION BWN 30

Code: 422664

RRP
€ 37.00

- NEOPRENE DOUBLE LINING
- REINFORCED PALM AND FINGERS



TECHNICAL FEATURES

Thickness	3mm			
Fabric Type	Neoprene			
Sizes	S	M	L	XL

GLOVES CAMO BLACK 30

Code: 422665

RRP
€ 37.00

- NEOPRENE DOUBLE LINING
- REINFORCED PALM AND FINGERS



TECHNICAL FEATURES

Thickness	3mm			
Fabric Type	Neoprene			
Sizes	S	M	L	XL

GLOVES AMARA 20

Code: 422752

RRP
€ 40.00

- NEOPRENE / PALM AND FINGERS IN ULTRA RESISTANT AMARA
- ADJUSTABLE VELCRO



TECHNICAL FEATURES

Thickness	2mm			
Fabric Type	Neoprene			
Sizes	S	M	L	XL

SOCKS ILLUSION BWN 30

Code: 422663

RRP
€ 39.00

- LINED EXTERIOR / OPEN CELL INTERIOR
- REINFORCED DOUBLE-LINED SOLE



TECHNICAL FEATURES

Thickness	3mm			
Fabric Type	Neoprene			
Sizes	S	M	L	XL

TECHNICAL SPECIFICATIONS



Suits	Polygon						Polygon Black		Merge	
	Jacket	Pants	Jacket	Pants	Jacket	Pants	Jacket	Pants	Jacket	Pants
Model										
Code	422304	422305	422306	422307	422308	422309	422320	422321	422310	422311
Colors										
Thickness	3 mm		5 mm		8-6,5 mm		5 mm		5 mm	
Sizes	2-3-4-5-6						2-3-4-5-6		2-3-4-5-6	
Maximum Elasticity	■						■		■	
Lining / Open cell	■						■		■	
3 Materials									■	
RRP	€ 165.00	€ 115.00	€ 185.00	€ 139.00	€ 215.00	€ 169.00	€ 165.00	€ 125.00	€ 249.00	€ 199.00



Suits	Explorer Camo Black					Illusion BWN					Illusion				
	Jacket	Pants	Jacket	Pants	Jacket	Jacket	Pants	Jacket	Pants	Jacket	Jacket	Pants	Jacket	Pants	Long John
Model															
Code	422040	422041	422038	422039	422037	422035	422036	422033	422034	422032	422487	422488	422484	422485	422486
Colors															
Thickness	3 mm		5 mm		7 mm	3 mm		5 mm		7mm	3 mm		5 mm		
Sizes	2-3-4-5-6					2-3-4-5-6					2-3-4-5-6				
Maximum Elasticity	■					■					■				
Lining / Open cell	■					■					■				
RRP	€ 155.00	€ 110.00	€ 175.00	€ 125.00	€ 185.00	€ 159.00	€ 110.00	€ 170.00	€ 130.00	€ 195.00	€ 159.00	€ 105.00	€ 165.00	€ 130.00	€ 159.00



Suits	Explorer					Explorer Sport			
	Jacket	Pants	Jacket	Pants	Long John	Jacket	Pants	Jacket	Long John
Model									
Code	422479	422480	422456	422457	422458	422312	422313	422466	422467
Colors									
Thickness	3 mm		5 mm			3 mm		5 mm	
Sizes	2-3-4-5-6					2-3-4-5-6			
Lining / Open cell	■					■			
Lining / Lining						■			
RRP	€ 119.00	€ 84.00	€ 135.00	€ 105.00	€ 125.00	€ 119.00	€ 95.00	€ 139.00	€ 129.00

TECHNICAL SPECIFICATIONS



Freediving Suits	Apnea Instinct				Prism Skin								Horizon 0.5	Horizon 2.0	
	Man		Lady		Man		Lady		Man		Lady		Unisex	Man	Lady
	Jacket	Pants	Jacket	Pants	Jacket	Pants	Jacket	Pants	Jacket	Pants	Jacket	Pants			
Code	422459	422460	422461	422462	422314	422315	422318	422319	422322	422323	422324	422325	422326	422316	422317
Colors															
Thickness	5 mm				3 mm				5 mm				0.5 mm	2 mm	
Sizes	2-3-4-5-6		1-2-3-4-5		2-3-4-5-6		1-2-3-4-5		2-3-4-5-6		1-2-3-4-5			2-3-4-5-6 1-2-3-4-5	
Maximum Elasticity	■				■				■				■	■	
Lining / Open cell	■														
Smooth / Lining					■				■					■	
Polyurethane													■		
RRP	€ 140.00	€ 110.00	€ 140.00	€ 110.00	€ 179.00	€ 129.00	€ 179.00	€ 129.00	€ 199.00	€ 149.00	€ 199.00	€ 149.00	€ 139.00	€ 235.00	



Gloves	Smooth Skin	Flex		Flex Gold		Black 25/45/55	Polygon BK 20/35/50	Illusion 30	Illusion BWN 30	Camo Black 30	Amara 20
Code	422755	422759	422750	422763	422762	422676	422675	422760	422664	422665	422752
Thickness	3,5 mm	2 mm	3 mm	3 mm	5 mm	2.5/4.5/5.5 mm	2/3.5/5 mm	3 mm	3 mm	3 mm	2 mm
Colors											
Sizes	S, M, L, XL	XS/S, M/L, XL/XXL	XS, M, XL	S, M, L, XL		XS/S, M, L/XL	XS/S, M, L/XL	S, M, L, XL	S, M, L, XL	S, M, L, XL	S, M, L, XL
RRP	€ 42.00	€ 34.00	€ 36.00	€ 40.00	€ 42.00	€ 39.00	€ 38.00	€ 35.00	€ 37.00	€ 37.00	€ 40.00



Socks	Smooth Skin 30	Flex		Flex Gold		Black 50/60	Polygon BK 30/50	Illusion BWN 30
Code	422654	422658	422657	422656	422660	422661	422674	422673
Thickness	3 mm	2 mm	3 mm	5 mm	3 mm	5 mm	5/6 mm	3 mm
Colors								
Sizes	S, M, L, XL	XS/S, M/L, XL/XXL		S, M, L, XL		XS/S, M/L, XL/XXL	XS/S, M/L, XL/XXL	S, M, L, XL
RRP	€ 36.00	€ 33.00	€ 35.00	€ 36.00	€ 40.00	€ 42.00	€ 38.00	€ 36.00

SIZE CHART

USA	1	2	3	4	5	6
EU	XS	S	M	L	XL	XXL
IT	1	2	3	4	5	6
A	inch 34-36	35-38	37-40	39-41	41-43	42-45
	cm 88/92	91 / 97	95 / 101	99 / 105	103 / 109	107 / 115
B	inch 28-29	30-33	33-35	34-37	36-38	37-41
	cm 72/76	77 / 83	83 / 89	87 / 93	91 / 97	95 / 103
C	inch 33-35	35-38	37-39	39-41	40-43	42-45
	cm 86/90	90 / 96	94 / 100	98 / 104	102 / 108	106 / 114
D	inch 19-20	20-21	21-22	22-23	23-24	24-25
	cm 50/52	52/55	54/57	56/59	58/61	60/63
E	inch 25-27	27-28	28-29	29-30	30-31	31-32
	cm 66/69	68/71	70/73	72/75	74/77	76/79
F	inch 62-64	65-68	67-70	69-71	71-72	72-74
	cm 160/164	166/172	170/176	174/180	178/184	182/188
USA	0	1	2	3	4	5
EU	XXS	XS	S	M	L	XL
IT	0	1	2	3	4	5
A	inch 30-31	33-35	34-37	36-38	37-40	39-41
	cm 77/81	83-89	87-93	91-97	95-101	99-105
B	inch 23-24	26-28	27-30	29-31	30-33	32-34
	cm 59/63	65-71	69-75	73-79	77-83	81-87
C	inch 31-33	34-37	36-38	38-40	39-41	41-43
	cm 80/85	87-93	91-97	95-101	99-105	103-109
D	inch 18-19	19-20	20-21	21-22	22-23	23-24
	cm 47/49	48-51	50-53	52-55	54-57	56-59
E	inch 24-25	25-26	26-27	27-28	28-29	29-30
	cm 62/64	64-67	66-69	68-71	70-73	72-75
F	inch 61-62	61-64	63-66	65-67	66-69	68-70
	cm 156/158	156-162	160-166	164-170	168-174	172-178

PLEASE NOTE: Freediving/Spearfishing wetsuits must fit well. Given the material used to manufacture them, the table is for reference only. We suggest trying the wetsuit at a Mares retailer.



2022

PNEUMATIC GUNS

CYRANO 1.1

Code: 423158♦

	RRP
42 cm NP	€ 255.00
55 cm NP	€ 269.00
55 cm WP	€ 285.00
70 cm WP	€ 299.00
90 cm WP	€ 325.00
100 cm WP	€ 339.00
110 cm WP	€ 355.00
120 cm WP	€ 369.00



- 40MM OUTER BARREL
- LIGHTER SINGLE-PIECE HEAD WITH SMALLER CONE
- 11MM INTERNAL BARREL IS SHIFTED UPWARD OFF-AXIS FOR A BETTER LINE OF SIGHT
- STAINLESS STEEL LINE RELEASE AND TRIGGER, BETTER FLUIDITY DURING THE SHOOT
- PISTON EVO, INCREASE IN SPEED, EASY LOADING, BETTER LUBRICATION
- OVERSIZED AIR PASSAGES IN THE INNER BARREL
- ERGONOMIC HANDLE WITH GRIP IN '.CYRANO BLUE' COLOR
- 7MM THREADED SHAFT ON GUN SIZES 42, 55 AND 70
- SHAFT RACE: 7MM SINGLE BARB TAHITIAN SHAFT ON GUN SIZES 90, 100, 110 AND 120
- LIGHTWEIGHT CARRYING BAG INCLUDED



TECHNICAL FEATURES

Internal barrel	11 mm							
Sizes	42NP	55NP	55WP	70WP	90WP	100WP	110WP	120WP
Shaft Race	Ø mm				7	7	7	7
	cm				97	105	122	132
Threaded Shaft	Ø mm	7	7	7	7			
	cm	35,9	56,9	56,9	67,1			
Operating pressure	BAR	13	16	16	20	22	24	26
Connecting Piston	Ø mm	1,5 mm						

CYRANO 1.3

Code: 423159♦

	RRP
45 cm NP	€ 229.00
55 cm NP	€ 245.00
55 cm WP	€ 259.00
70 cm WP	€ 275.00
90 cm WP	€ 289.00
100 cm WP	€ 305.00
110 cm WP	€ 319.00
120 cm WP	€ 335.00



- 40MM OUTER BARREL
- LIGHTER SINGLE-PIECE HEAD WITH SMALLER CONE
- 13MM INTERNAL BARREL IS SHIFTED UPWARD OFF-AXIS FOR A BETTER LINE OF SIGHT
- STAINLESS STEEL LINE RELEASE AND TRIGGER, BETTER FLUIDITY DURING THE SHOOT
- PISTON EVO, INCREASE IN SPEED, EASY LOADING, BETTER LUBRICATION
- OVERSIZED AIR PASSAGES IN THE INNER BARREL
- ERGONOMIC HANDLE WITH GRIP IN '.CYRANO BLUE' COLOR
- 8MM THREADED SHAFT ON GUN SIZES 42, 55 AND 70
- SHAFT RACE: 8MM SINGLE BARB TAHITIAN SHAFT ON GUN SIZES 90, 100, 110 AND 120
- LIGHTWEIGHT CARRYING BAG INCLUDED



TECHNICAL FEATURES

Internal barrel	13 mm							
Sizes	42NP	55NP	55WP	70WP	90WP	100WP	110WP	120WP
Shaft Race	Ø mm				8	8	8	8
	cm				97	105	122	132
Threaded Shaft	Ø mm	8	8	8	8			
	cm	36,9	51,9	51,9	66,9			
Operating Pressure	BAR	13	13	13	16	16	18	22
Connecting Piston	Ø mm	1,5 mm						

WP: with power adjusting system
♦ While stocks last

STEN

Code: **413105**

	RRP
41 cm NP	€ 155.00
58 cm NP	€ 162.00
70 cm WP	€ 182.00



- 40MM OUTER BARREL
- LOW WEIGHT SINGLE PIECE HEAD
- REINFORCED NOSE CONE
- 8MM THREADED SHAFT
- INCLUDES HOLSTER

JET

Code: **413106**

	RRP
41 cm NP	€ 140.00
58 cm NP	€ 150.00
70 cm NP	€ 160.00



- 40MM OUTER BARREL
- LOW WEIGHT SINGLE-PIECE HEAD
- REINFORCED NOSE CONE
- 8MM THREADED SHAFT



TECHNICAL FEATURES

Internal barrel		13 mm		
Sizes		41NP	58NP	70WP
Shaft Race	Ø mm	8	8	8
	cm	36.9	51.9	66.9
Threaded Shaft	Ø mm	8	8	8
	cm	36.9	51.9	66.9
Operating pressure	BAR	13	13	16
Connecting Piston	Ø mm	1.5 mm		

TECHNICAL FEATURES

Internal barrel		13 mm		
Sizes		41NP	58NP	70NP
Shaft Race	Ø mm	8	8	8
	cm	36.9	51.9	66.9
Threaded Shaft	Ø mm	8	8	8
	cm	36.9	51.9	66.9
Operating pressure	BAR	13	13	16
Connecting Piston	Ø mm	3 mm		

WP: with power adjusting system

TECHNICAL SPECIFICATIONS

NUMBER OF PUMPS* (APPROX.)					
Model	BARREL PRESSURE BAR / kPa / PSI				
	10 / 1000 / 145	15 / 1500 / 217,5	20 / 2000 / 290	25 / 2500 / 362,5	30 / 3000 / 435
Cyrano 1.1 42 Cyrano 1.3 42	75	120	170	230	300
Cyrano 1.1 55 Cyrano 1.3 55	110	170	250	340	440
Cyrano 1.1 70 Cyrano 1.3 70	170	270	390	520	680
Cyrano 1.1 90 Cyrano 1.3 90	200	320	460	620	800
Cyrano 1.1 100 Cyrano 1.3 100	260	420	600	800	1040
Cyrano 1.1 110 Cyrano 1.3 110	300	480	700	950	1200
Cyrano 1.1 120 Cyrano 1.3 120	340	540	800	1100	1360
Sten 41	60	130	170	210	240
Sten 58 Sten 11 58	100	160	230	310	400
Sten 70 Sten 11 70	140	220	320	430	560
Jet 41	50	100	150	180	220
Jet 58	70	150	250	380	500
Jet 70	130	190	290	400	720

All Mares pneumatic spearguns are produced and delivered pressurized at manufacturer recommended specs.
* Number of pumps listed to pressurize pneumatic gun is based upon barrel chamber beginning at empty 0 BAR / PSI.



Code	Cyrano 1.1								Cyrano 1.3								Sten			Jet			
	423158								423159								413105			413106			
Sizes	42NP	55NP	55WP	70WP	90WP	100WP	110WP	120WP	42NP	55NP	55WP	70WP	90WP	100WP	110WP	120WP	41NP	58NP	70WP	41NP	58NP	70NP	
Shaft Race	Ø mm								Ø mm								Ø mm			Ø mm			
	7								8								8			8			
Threaded Shaft	cm								cm								cm			cm			
	7								8								8			8			
Operating pressure	BAR	13	16	16	20	22	24	24	26	13	13	13	16	16	18	18	22	13	13	16	13	13	16
Connecting piston	Ø mm								Ø mm								Ø mm			Ø mm			
Compact head	1,5 mm								1,5 mm								1,5 mm			3 mm			
Internal barrel	mm								mm								mm			mm			
Ergonomic handle	11 mm								13 mm								13 mm			13 mm			
Stainless steel side line releaser	■								■								■			■			
Stainless steel trigger	■								■								■			■			
Cone with steel line guide	■								■								■			■			
Dedicated case included	■								■								■			■			
Manual injector included	■								■								■			■			
RRP	€ 255	€ 269	€ 285	€ 299	€ 325	€ 339	€ 355	€ 369	€ 229	€ 245	€ 259	€ 275	€ 289	€ 305	€ 319	€ 335	€ 155	€ 162	€ 182	€ 140	€ 150	€ 160	



2022

SLING GUNS

STRIKE POLYGON**NEW**

Code: 423431

	RRP
75 cm	€ 265.00
90 cm	€ 280.00
100 cm	€ 295.00
115 cm	€ 310.00



- THE 28MM DIAMETER CIRCULAR BARREL IS CONSTRUCTED OF ANTI-CORROSIVE EXTRUDED ALUMINUM WITH A LOW FRICTION INTEGRATED SHAFT GUIDE
- OPEN MUZZLE CONFIGURATION WITH A FRICTION REDUCTION SYSTEM BETWEEN THE SLINGS AND THE BARREL
- THE MUZZLE ACCOMMODATES TWO 14MM CIRCULAR SLINGS
- A SIMPLIFIED AND OPEN LINE OF SIGHT INCREASES PRECISION AND INSTINCTIVE SHOOTING
- LINE RETAINERS ON THE MUZZLE AND HANDLE ARE LOW PROFILE WITH A CLEAN, SIMPLE DESIGN
- LINE RELEASE MECHANISM IS CONSTRUCTED IN STAINLESS STEEL AND OPTIMIZED FOR LOADING WITH THICKER BANDS
- TRIGGER IS DESIGNED IN A GEOMETRIC SHAPE FOR DYNAMIC SHOOTING
- LATEX CIRCULAR SLINGS COME IN A NEW INDIGO COLOR, MINIMIZING THE REFLECTION OF UV RAYS VISIBLE TO FISH
- DYNEEMA WISHBONE
- 7MM TAHITIAN SHAFT IN 17-4 PH TEMPERED STEEL
- 80MM HORIZONTAL REEL WITH A MICROMETRIC ADJUSTMENT CLUTCH AND 50 METERS OF 1.7MM DIAMETER LINE
- NEW ERGONOMIC HANDLE IN A NON-SLIP GEOMETRIC SHAPE. THE ANGLE OF THE HANDLE IN RESPECT TO THE BARREL IS DESIGNED FOR CONTINUITY WITH THE SHOOTERS ARM, ABSORBING RECOIL
- WIDE SHOOTING LINE-RETAINER CAN BE POSITIONED ON EITHER RIGHT OR LEFT SIDE
- RETRACTABLE SLIDING SAFETY MECHANISM
- REEL HOUSING WITH INSERT ACCOMMODATES USE WITH ROLLER MUZZLES
- NEW POLYGON CAMOUFLAGE ON THE BARREL

BARREL SECTION

ø 6 / 6.25 / 6.5 / 7 mm

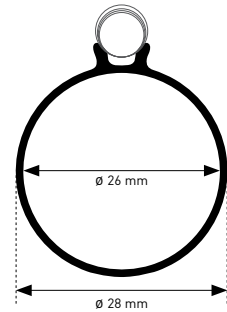
**TECHNICAL FEATURES**

Barrel		28			
Sizes		75	90	100	115
Shaft Strike	ø mm	7	7	7	7
	cm	115	130	140	155
Two S-Power Speed circular sling	ø mm	14	14	14	14
	cm	50	58	64	72

DETAILS

STRIKE

Code: 423430

	RRP
55 cm	€ 210.00
75 cm	€ 220.00
90 cm	€ 230.00
100 cm	€ 250.00
115 cm	€ 260.00



- A 28MM DIAMETER CIRCULAR BARREL IS CONSTRUCTED OF ANTI-CORROSIVE EXTRUDED ALUMINUM WITH A LOW FRICTION INTEGRATED SHAFT GUIDE
- OPEN MUZZLE CONFIGURATION WITH A FRICTION REDUCTION SYSTEM BETWEEN THE SLINGS AND THE BARREL
- THE MUZZLE ACCOMMODATES ONE OR TWO CIRCULAR SLINGS, RANGING FROM 14MM TO 18MM IN DIAMETER
- SIMPLIFIED AND OPEN LINE OF SIGHT INCREASES PRECISION AND INSTINCTIVE SHOOTING
- LINE RETAINERS ON THE MUZZLE AND HANDLE ARE LOW PROFILE WITH A CLEAN AND SIMPLE DESIGN
- LINE RELEASE MECHANISM IS CONSTRUCTED IN STAINLESS STEEL AND OPTIMIZED FOR LOADING WITH THICKER BANDS
- TRIGGER IS DESIGNED IN A GEOMETRIC SHAPE FOR DYNAMIC SHOOTING
- LATEX CIRCULAR SLINGS COME IN A NEW INDIGO COLOR MINIMIZING REFLECTION OF UV RAYS VISIBLE TO FISH
- DYNEMA WISHBONE
- 6.5MM TAHITIAN SHAFT IN 17-4 PH TEMPERED STEEL
- 80MM HORIZONTAL REEL WITH A MICROMETRIC ADJUSTMENT CLUTCH AND 50 METERS OF 1.7MM DIAMETER LINE
- NEW ERGONOMIC HANDLE IN A NON-SLIP GEOMETRIC SHAPE. THE ANGLE OF THE HANDLE IN RESPECT TO THE BARREL IS DESIGNED FOR CONTINUITY WITH THE SHOOTERS ARM, ABSORBING RECOIL
- WIDE SHOOTING LINE-RETAINER CAN BE POSITIONED ON EITHER RIGHT OR LEFT SIDE
- RETRACTABLE SLIDING SAFETY MECHANISM
- REEL HOUSING WITH INSERT ACCOMMODATES USE WITH ROLLER MUZZLES

BARREL SECTION

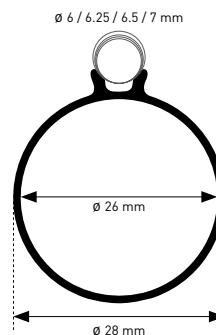

TECHNICAL FEATURES

Barrel	28					
Sizes	55	75	90	100	115	
Shaft Strike	Ø mm	6,5	6,5	6,5	6,5	6,5
	cm	95	115	130	140	155
S-Power Speed circular sling	Ø mm	17	17	17	-	-
	cm	42	54	63	-	-
Two S-Power Speed circular slings	Ø mm	-	-	-	14	14
	cm	-	-	-	64	72

DETAILS



STRIKE ELEMENT

NEW

Code: 423432

	RRP
55 cm	€ 180.00
75 cm	€ 190.00
90 cm	€ 200.00
100 cm	€ 210.00

- THE 28MM DIAMETER CIRCULAR BARREL IS CONSTRUCTED OF ANTI-CORROSIVE EXTRUDED ALUMINUM
- OPEN MUZZLE CONFIGURATION WITH A FRICTION REDUCTION SYSTEM BETWEEN THE SLINGS AND THE BARREL
- THE MUZZLE ACCOMMODATES ONE 17MM CIRCULAR SLING
- A SIMPLIFIED AND OPEN LINE OF SIGHT INCREASES PRECISION AND INSTINCTIVE SHOOTING
- LINE RETAINERS ON THE MUZZLE AND HANDLE ARE LOW PROFILE WITH A CLEAN, SIMPLE DESIGN
- LINE RELEASE MECHANISM IS CONSTRUCTED IN STAINLESS STEEL AND OPTIMIZED FOR LOADING WITH THICKER BANDS
- TRIGGER IS DESIGNED IN A GEOMETRIC SHAPE FOR DYNAMIC SHOOTING
- LATEX CIRCULAR SLINGS COME IN A NEW INDIGO COLOR, MINIMIZING THE REFLECTION OF UV RAYS VISIBLE TO FISH
- DYNEEMA WISHBONE
- 6MM TAHITIAN SHAFT IN 17-4 PH TEMPERED STEEL
- NEW ERGONOMIC HANDLE IN A NON-SLIP GEOMETRIC SHAPE. THE ANGLE OF THE HANDLE IN RESPECT TO THE BARREL IS DESIGNED FOR CONTINUITY WITH THE SHOOTERS ARM, ABSORBING RECOIL
- WIDE SHOOTING LINE-RETAINER CAN BE POSITIONED ON EITHER RIGHT OR LEFT SIDE
- RETRACTABLE SLIDING SAFETY MECHANISM
- REEL HOUSING WITH INSERT ACCOMMODATES USE WITH ROLLER MUZZLES

BARREL SECTION

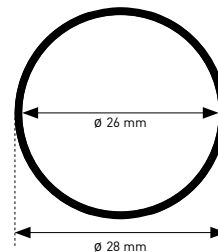

TECHNICAL FEATURES

Barrel		28			
Sizes		55	75	90	100
Shaft Strike	$\varnothing \text{ mm}$	6	6	6	6
	cm	95	115	130	140
S-Power circular sling	$\varnothing \text{ mm}$	17	17	17	17
	cm	42	54	63	70

DETAILS



VIPER PRO DS

Code: 423426

	RRP
75 cm	€ 229.00
90 cm	€ 235.00
100 cm	€ 242.00
110 cm	€ 252.00



- RIGID ANODIZED ALUMINUM BARREL WITH UPPER SHAFT GUIDE AND LOWER LINE GUIDE
- OPEN MUZZLE CONFIGURATION, WITH OFF-AXIS HOLES
- HIGHLY SENSITIVE TRIGGER MECHANISM IN A REVERSED POSITION
- STAINLESS STEEL SIDE LINE RELEASE
- STAINLESS STEEL TRIGGER
- PREFORMED HANDLE WITH HIGH-FUNCTIONALITY ANATOMIC GRIP
- VARIABLE DEFORMATION REINFORCED LOADING PAD
- 6.5 MM SINGLE BARB TAHITIAN HARDY SHAFT
- TWO 16 MM S-POWER SPEED CIRCULAR SLINGS WITH DYNEEMA® WISHBONE
- INCLUDES SPIRO VERTICAL REEL

BARREL SECTION

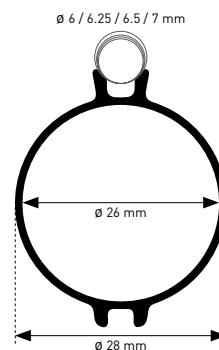

TECHNICAL FEATURES

Barrel		28			
Sizes		75	90	100	110
Shaft Hardy	Ø mm	6.5	6.5	6.5	6.5
	cm	115	130	140	150
Two S-Power Speed circular slings	Ø mm	16	16	16	16
	cm	42	50	55	60
Vertical Reel		65	65	87	87

HANDLE VIPER PRO DS

Code : 423994 ♦



♦ While stocks last

VIPER PRO

Code: 423416

	RRP
75 cm	€ 205.00
90 cm	€ 210.00
100 cm	€ 220.00
110 cm	€ 230.00

- RIGID ANODIZED ALUMINUM BARREL WITH UPPER SHAFT GUIDE AND LOWER LINE GUIDE
- OPEN MUZZLE CONFIGURATION, WITH OFF-AXIS HOLES
- HIGHLY SENSITIVE TRIGGER MECHANISM IN A REVERSED POSITION
- STAINLESS STEEL SIDE LINE RELEASE
- DISTANCE BETWEEN TRIGGER AND HANDLE CAN BE CUSTOMIZED
- PREFORMED HANDLE WITH A HIGH-FUNCTIONALITY ANATOMIC GRIP
- VARIABLE DEFORMATION REINFORCED LOADING PAD
- SHAFT HARDY 6.5MM SINGLE BARB TAHITIAN SHAFT
- 17.5MM S-POWER SPEED CIRCULAR SLING WITH DYNEEMA® WISHBONE
- INCLUDES SPIRO VERTICAL REEL



TECHNICAL FEATURES

Barrel	28				
Sizes	75	90	100	110	
Shaft Hardy	Ø mm	6.5	6.5	6.5	6.5
	cm	115	130	140	150
S-Power Speed circular sling	Ø mm	17.5	17.5	17.5	17.5
	cm	48	60	65	70
Vertical Reel	65	65	87	87	

DETAILS



SNIPER PS

Code: 423424

	RRP
45 cm	€ 85.00
55 cm	€ 92.00
75 cm	€ 99.00
90 cm	€ 105.00

- OUTER BARREL IN ANODIZED ALUMINUM
- COMPACT MUZZLE FOR PAIR OF SLINGS
- SHAFT RELEASE AND LINE RELEASE MADE OUT OF STAINLESS STEEL
- ERGONOMIC HANDLE MIMICS THE SHAPE USED ON VIPER PRO AND CYRANO EVO HF
- SET UP FOR A VERTICAL SPIRO REEL
- SHAFT GALVANIZED STEEL PR80, 6.5MM SINGLE BARB TAHITIAN SHAFT
- PAIR OF 16MM S-POWER SLINGS
- RACE WISHBONE



TECHNICAL FEATURES

Barrel	28				
Sizes	45	55	75	90	
Tahitian shaft PR80	Ø mm	6.5	6.5	6.5	6.5
	cm	85	95	115	130
S-Power pair of slings	Ø mm	16	16	16	16
	cm	16	19	22	24

DETAILS

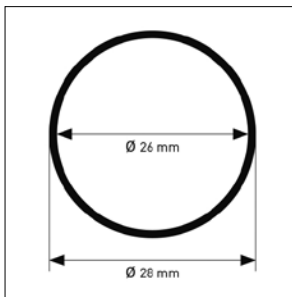

SNIPER

Code: 423421

	RRP
45 cm	€ 89.00
55 cm	€ 95.00
75 cm	€ 105.00
90 cm	€ 110.00

- BARREL IN ANODIZED ALUMINUM
- COMPACT MUZZLE WITH CIRCULAR SLING
- SHAFT RELEASE AND LINE RELEASE MADE OUT OF STAINLESS STEEL
- ERGONOMIC HANDLE MIMICS THE SHAPE USED ON VIPER PRO AND CYRANO EVO HF
- SET UP FOR A VERTICAL SPIRO REEL
- SHAFT GALVANIZED STEEL PR80, 6.5MM SINGLE BARB TAHITIAN SHAFT
- 16MM S-POWER CIRCULAR SLING
- RACE WISHBONE



TECHNICAL FEATURES

Barrel	28				
Sizes	45	55	75	90	
Tahitian shaft PR80	Ø mm	6.5	6.5	6.5	6.5
	cm	75	85	115	130
S-Power circular sling	Ø mm	16	16	16	16
	cm	30	34	50	60

DETAILS

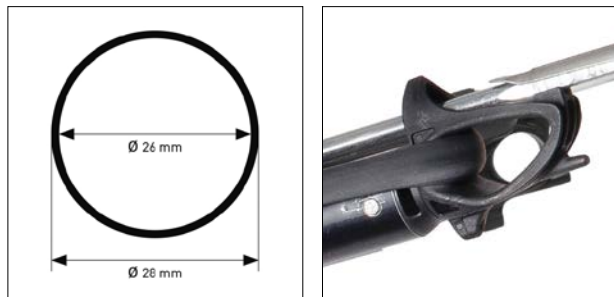

SNIPER ALPHA

Code: 423422

	RRP
35 cm	€ 69.00
45 cm	€ 75.00
55 cm	€ 82.00
75 cm	€ 88.00

- OUTER BARREL IN ANODIZED ALUMINUM
- COMPACT MUZZLE WITH CIRCULAR SLING
- SHAFT RELEASE AND LINE RELEASE MADE OUT OF STAINLESS STEEL
- ERGONOMIC HANDLE MIMICS THE SHAPE USED ON VIPER PRO AND CYRANO EVO HF
- SET UP FOR A VERTICAL SPIRO REEL
- SHAFT GALVANIZED STEEL PR80, 7MM THREADED
- SINGLE-BARB BULLET SPEAR TIP
- 14MM S-POWER CIRCULAR SLING
- RACE WISHBONE



TECHNICAL FEATURES

Barrel	25				
Sizes	35	45	55	75	
Thread shaft PR80	Ø mm	7	7	7	7
	cm	58	68	78	98
S-Power circular sling	Ø mm	14	14	14	14
	cm	28	30	34	50

DETAILS

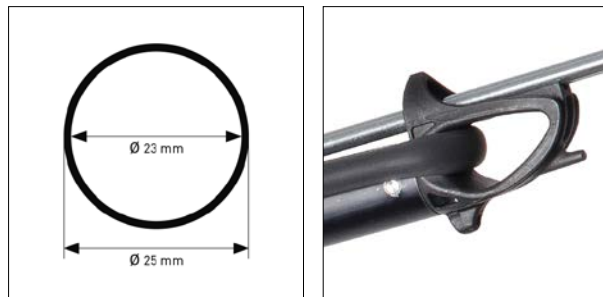

SLING GUNS / TECHNICAL SPECIFICATIONS



	Strike Polygon				Strike				Strike Element				Viper Pro DS				Viper Pro				Sniper PS				Sniper				Sniper Alpha													
Code	423431				423430				423432				423426				423416				423424				423421				423422													
Sizes	75	90	100	115	55	75	90	100	115	55	75	90	100	75	90	100	110	75	90	100	110	45	55	75	90	45	55	75	90	35	45	55	75									
Barrel	28				28				28				28				28				28				25																	
Shaft Strike	■				■				■																																	
Shaft Hardy													■				■																									
Shaft	∅ mm		7		7		7		7		6.5		6.5		6.5		6.5		6		6		6		6		6.5		6.5		6.5		6.5		7		7		7		7	
	cm		115		130		140		155		95		115		130		140		95		115		130		140		115		130		140		150		85		95		115		130	
S-Power circular sling																																										
S-Power pair of slings																					■																					
S-Power Speed circular sling									■								■																									
Two S-Power Speed circular slings	■				■								■																													
Slings	∅ mm		14		14		14		14		17		17		17		17		16		16		16		16		17.5		17.5		17.5		17.5		16		16		16		16	
	cm		50		58		64		72		42		54		63		72		42		54		63		70		42		50		55		60		48		60		65		70	
Reel	■				■								■				■																									
RRP	€ 265	€ 280	€ 295	€ 310	€ 210	€ 220	€ 230	€ 250	€ 260	€ 180	€ 190	€ 200	€ 210	€ 229	€ 235	€ 242	€ 252	€ 205	€ 210	€ 220	€ 230	€ 85	€ 92	€ 99	€ 105	€ 89	€ 95	€ 105	€ 110	€ 69	€ 75	€ 82	€ 88									

HAND SPEAR FIBER

NEW

Code: **423268**

RRP
€ 59.00

- HAND SPEAR MADE IN FIBERGLASS
- 2 PIECES
- REPLACEABLE STEEL BARB
- REPLACEABLE SLING

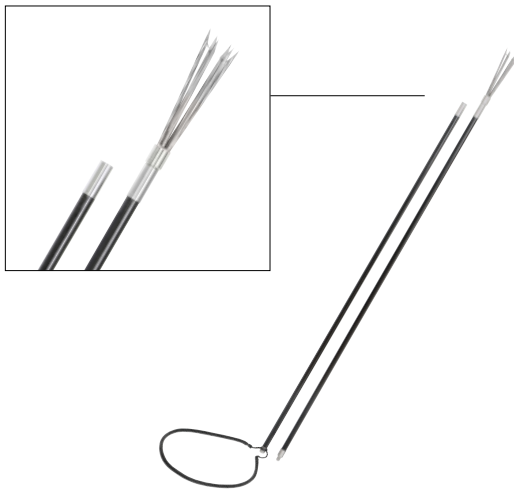

HAND SPEAR HERO

NEW

Code: **423269**

RRP
€ 52.00

- HAND SPEAR MADE IN ANODIZED ALUMINIUM
- 2 PIECES
- REPLACEABLE STEEL BARB
- REPLACEABLE SLING

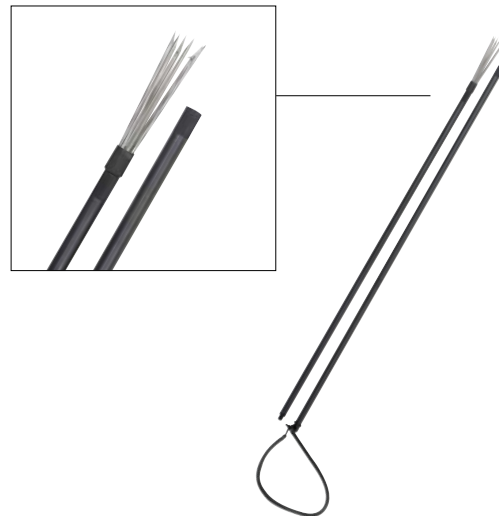



mares
pure passion

2022

ACCESSORIES

◇ Please note that some sizes are only available while stocks last

ASCENT DRY DUFFLE

Code: 425566

RRP
€ 135.00



- WATERPROOF DUFFLE WITH WHEELS FOR EASY TRANSPORT
- FOLDING CLOSURE
- ERGONOMIC SHOULDER STRAPS TO CARRY IT AS A BACKPACK
- INNER WEIGHT RETAINER STRAPS WITH VELCRO® BRAND FASTENERS
- LARGE EXTERNAL WATERPROOF POCKET



DETAILS



Wheels for easy transport



Folding closure

TECHNICAL FEATURES

Dimensions (LxWxH)	Unit Net Weight	Volume
100x33x65 cm	2,3 kg	140 L

ASCENT DRY TITAN

NEW

Code: 425571

RRP
€ 79.00



- SPACIOUS 840 DENIER TARPULIN BAG THAT CAN CARRY 100KG
- HEAT SEALED BAG WITH NO STITCHING
- ADJUSTABLE HANDLES ARE ATTACHED BY SNAP HOOKS TO WELDED BASE PLATES
- SIDE DRAIN VALVE



DETAILS



Side drain valve



Ergonomic shoulder strap

TECHNICAL FEATURES

Dimensions (LxWxH)	Unit Net Weight	Volume
90x46x35 cm	1,95 kg	144 L

ASCENT DRY BACKPACK

Code: 425565

RRP
€ 95.00



- WATERPROOF AND DURABLE BACKPACK
- ADJUSTABLE, ERGONOMIC SHOULDER STRAP
- INNOVATIVE REAR ZIP
- WATERPROOF KEY POCKET
- EXTERNAL DOCUMENT POUCH
- SIDE GUN RETAINER
- SIDE FIN HOLDER



DETAILS



Waterproof wetsuit compartment



Side gun retainer

TECHNICAL FEATURES

Dimensions (LxWxH)	Unit Net Weight	Volume
35x30x90 cm	1,6 kg	75 L

ASCENT DRY FIN BAG

Code: 425568

RRP
€ 95.00



- WATERPROOF WETSUIT COMPARTMENT
- ERGONOMIC SHOULDER STRAPS
- WATERPROOF KEY HOLDER
- BOTTLE HOLDER
- FITS VERY LONG FINN, A WETSUIT, MASK, SPEARGUN AND ALL YOU NEED FOR EASY TRANSPORTATION



DETAILS



Ergonomic shoulder straps



External pocket

TECHNICAL FEATURES

Dimensions (LxWxH)	Unit Net Weight
30x28x120 cm	1,6 kg

ASCENT LONG FIN BAG

Code: 425569

RRP
€ 55.00



- FITS 2 LONG PAIRS OF FINN AND MASKS
- EXTERNAL DOCUMENT POUCH
- ADJUSTABLE SHOULDER STRAP



TECHNICAL FEATURES

Dimensions (LxWxH)	Unit Net Weight	Capacity
20x22x110 cm	800gr	2 pair of fins

ASCENT DRY GUN BAG

Code: 425567

RRP
€ 75.00



- WATERPROOF BAG
- GUN RETAINER WITH VELCRO® BRAND FASTENERS INSIDE
- FITS UP TO 6 SPEARGUNS
- LARGE EXTERNAL WATERPROOF MASK/DOCUMENT POCKET



TECHNICAL FEATURES

Dimensions (DxH)	Unit Net Weight	Capacity
20x180 cm	1,2 kg	6 guns

ATTACK MONOFIN

Code: 425563

RRP
€ 77.00



- A BAG FOR TRANSPORTING AND PROTECTING THE MARES RACE MONOFIN
- HORIZONTAL ZIP TO ACCESS THE FRONT POCKET
- ADJUSTABLE SHOULDER STRAP AND HANDLE ON SIDE



TECHNICAL FEATURES

Dimensions (LxWxH)	Unit Net Weight	Volume
77 x 68.5 x 19cm	1kg	100.2l

ATTACK DRY BAG

Code: 425557

RRP
€ 39.00

- HANDY DRY BAG WITH SHOULDER STRAP
- IDEAL FOR HOLDING WET EQUIPMENT OR CLOTHING YOU WANT TO PROTECT FROM THE WATER
- DIMENSIONS: 74 X 58CM (40 LITERS)



TECHNICAL FEATURES

Dimensions (LxWxH)	Unit Net Weight	Volume
75 x 58cm	0.5kg	40l

ATTACK MESH

Code: **425554** Attack **Mesh 700**

RRP
€ 8.50

Code: **425555** Attack **Mesh 450**

RRP
€ 7.50

- STURDY WOVEN MESH BAG
- STRAP CLOSURE

TECHNICAL FEATURES

Dimensions (LxWxH) Attack Mesh 700
70 x 45cm
Dimensions (LxWxH) Attack Mesh 450
40 x 35cm



ARGO

Code: **425615**

RRP
€ 32.00

- COMPACT KNIFE WITH ERGONOMIC HANDLE
- 3 MM STAINLESS STEEL BLADE, LENGTH 72MM
- MICRO SERRATION TO GUARANTEE EXCELLENT CUTTING POWER
- THE QUICK-RELEASE SYSTEM MEANS YOU CAN USE IT QUICKLY
- CAN BE STRAPPED ON THE ARM, CALF OR BELT
- TWO ADJUSTABLE VELCRO® BRAND FASTENERS



ARGO TITANIUM

Code: **425616**

RRP
€ 62.00

- COMPACT KNIFE WITH ERGONOMIC HANDLE
- 3MM TITANIUM BLADE, LENGTH 72MM
- MICRO-SERRATION TO GUARANTEE EXCELLENT CUTTING POWER
- THE QUICK-RELEASE SYSTEM MEANS YOU CAN USE IT QUICKLY
- CAN BE STRAPPED ON THE ARM, CALF OR BELT
- TWO ADJUSTABLE VELCRO® BRAND FASTENERS



IAGO

Code: **425614**

RRP
€ 65.00

- KNIFE WITH ERGONOMIC HANDLE
- 4MM 420A STAINLESS STEEL BLADE, PVD-TREATED
- LENGTH OF BLADE: 98MM
- MICRO-SERRATION ALONG THE ENTIRE BLADE, EXCELLENT CUTTING POWER
- BLADE WITH HOLE FOR FREEING SHAFTS STUCK IN THE ROCKS
- THE QUICK-RELEASE SYSTEM MEANS YOU CAN USE IT QUICKLY
- CAN BE STRAPPED ON THE ARM, CALF OR BELT
- TWO STRAPS, QUICK-RELEASE BUCKLES



DAGGER

Code: **425610**

RRP
€ 79.00

- KNIFE WITH ERGONOMIC HANDLE
- 4MM 420A STAINLESS STEEL BLADE, PVD-TREATED
- LENGTH OF BLADE: 98MM
- MICRO-SERRATION TO GUARANTEE EXCELLENT CUTTING POWER
- THE QUICK-RELEASE SYSTEM MEANS YOU CAN USE IT QUICKLY
- CAN BE STRAPPED ON THE ARM, CALF OR BELT
- TWO STRAPS AND QUICK RELEASE BUCKLES



SNAKE 2.1

Code: **425617**

RRP
€ 59.00

- STAINLESS STEEL BLADE
- LENGTH OF BLADE: 134 MM
- ONE CUTTING EDGE AND ONE MICRO-SERRATED SHEARING EDGE
- HOLE FOR FREEING SHAFTS STUCK IN ROCKS AND A SHAFT RECTIFIER
- SOFT, ANTI-SLIP HANDLE
- ANTI-CORROSION SYSTEM WITH ANODE IN THE HANDLE
- SEMI-RIGID SCABBARD THAT CAN BE FASTENED TO THE LEG OR A BELT
- TWO STRAPS, QUICK-RELEASE BUCKLES



HERO POLYGON

Code: **425618**

RRP
€ 26.00

- COMPACT KNIFE, TOTAL LENGTH: 17.5CM
- STAINLESS STEEL BLADE
- LENGTH OF BLADE: 7CM
- ONE CUTTING EDGE AND ONE MICRO-SERRATED SHEARING EDGE
- ERGONOMIC HANDLE WITH ANTI-LOSS SYSTEM
- EASY TO USE WITH GLOVES
- HOLE FOR FREEING SHAFTS STUCK IN ROCKS
- STURDY CORDURA SHEATH
- CAN BE STRAPPED ON THE BELT



FISH STRINGER

Code: **423823**

RRP
€ 15.00

- MONOFILAMENT WITH PIN FOR CONTAINING YOUR SPEARFISHING CATCHES



FISH STRINGER KIT

Code: **423929**

- THE FISH PIN KIT CONSISTS OF A PIN, A MONOFILAMENT AND A SUPPORT FOR FIX YOUR PREY TO THE BELT.



HERO POLYGON SHORT

Code: **425619**

RRP
€ 29.00

- ULTRA-COMPACT KNIFE, TOTAL LENGTH: 13CM
- STAINLESS STEEL BLADE
- LENGTH OF BLADE: 7CM
- ONE CUTTING EDGE AND ONE MICRO-SERRATED SHEARING EDGE
- ERGONOMIC, ONE-FINGER HANDLE WITH ANTI-LOSS SYSTEM
- EASY TO USE WITH GLOVES
- HOLE FOR FREEING SHAFTS STUCK IN ROCKS
- STURDY CORDURA SHEATH
- DESIGNED TO BE ATTACHED TO THE ARM OR CALF
- TWO ADJUSTABLE VELCRO® BRAND FASTENERS

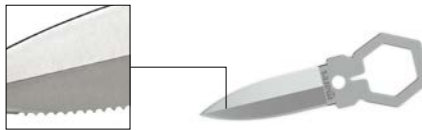

STRING RELEASER

Code: **425620**

RRP
€ 25.00

- HOLE FOR FREEING SHAFTS STUCK IN ROCKS AND A SHAFT RECTIFIER

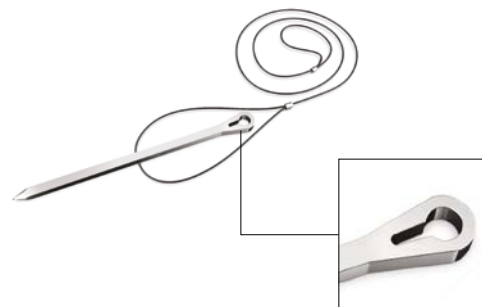

EOS ALPHA

Code: **425663**

RRP
€ 59.00

- SINGLE 1-WATT LED
- REFLECTOR - POLYCARBONATE (HOT SPOT)
- SLIDING MAGNETIC SWITCH WITH CONTINUOUS-ON OR OFF POSITION
- POWERED BY 4 1.5V AA BATTERIES (NOT INCLUDED)
- 900 MINUTES OF CONTINUOUS BURN TIME, 2100 MINUTES WITH INTERMITTENT 60 SECOND ON/OFF
- WATERPROOF DOWN TO 50M / 165FT



TECHNICAL FEATURES

Max depth	50 m/164ft
Switch	Magnetic switch (continuous-on or off position)
Batteries (not included)	4AA Alkaline 4AA Rechargeable(2700 mAh)
Reflector	Polycarbonate (Hot Spot)
Front lens	Polycarbonate, 3mm thick
Head	Polycarbonate
Maximum diameter (head)	43mm
Diameter of tubular grip (body)	25mm
Total length	153mm
Bulb	Mono LED 1W/120 lumens
Color temperature	6750 °K

EOS BEAM

Code: **425664**

RRP
€ 125.00

- CREE LED 1053 LUMENS
- POWERFUL LIGHT BEAM
- VERY CONCENTRATED BEAM
- VISUAL BATTERY INDICATOR
- EASY-TO-USE SWITCH
- HANDY AND COMPACT
- LED CHARGE INDICATOR
- IN-HOUSE RECHARGEABLE BATTERY
- USB CHARGER CABLE
- ADJUSTABLE WRIST STRAP
- PADDED CASE WITH ZIP



TECHNICAL FEATURES

Bulb	XM-L2
Switch Mode	High
Led lumens (25°)	1000
Burn time (min)	90
Color Temperature	5800 - 7300
Light beam (1m distance)	Hot Spot (12°)
(mm)	220
Rechargeable Batteries	1x ICR18650
Time to charge	300min
Total length	158.7mm
Head diameter	28mm
Body diameter	26mm
Weight with batteries	188.5g
Max. operation depth	100m

HYDRO PROPEL

NEW

Code: 425722

RRP
€ 65.00

- VERY LARGE BUOY WITH RUGGED OUTER COVER
- ORANGE NYLON OFFERS GREAT RESISTANCE AND VISIBILITY
- 2 LARGE D-RINGS WITH OPTIMIZED DRAG POINTS INCREASE GLIDE OVER THE WATER
- 6 LARGE NYLON D-RINGS
- 8 LARGE NYLON D-RINGS ON THE SIDE
- 20CM X 20CM DIVE FLAG
- PUMP INCLUDED
- INFLATABLE UP TO 0.15 BAR
- DOUBLE CHAMBER
- SHOULDER BAND
- EQUIPMENT FIXING SYSTEM
- PERFECT BUOYANCY
- MESH POCKET
- 50 LITRE CAPACITY



HYDRO TORPEDO LARGE

Code: 425717

RRP
€ 65.00

- LARGE BUOY WITH RUGGED OUTER COVER
- 500D ORANGE PVC OFFERING GREAT RESISTANCE, VISIBILITY AND A SMOOTH SURFACE FOR EASE OF MOVEMENT
- S.S. D-RING WITH DRAG POINT OPTIMIZED TO INCREASE GLIDE OVER THE WATER
- 6 NYLON D-RINGS
- 20 METERS OF FLOAT LINE + NYLON SNAP INCLUDED
- 30.5CM X 30.5CM DIVE FLAG



HYDRO TORPEDO

Code: 425718

RRP
€ 49.00

- BUOY WITH A RUGGED OUTER COVER
- 500D ORANGE PVC OFFERING GREAT RESISTANCE, VISIBILITY AND A SMOOTH SURFACE FOR EASE OF MOVEMENT
- 20 METERS OF FLOAT LINE + NYLON SNAP INCLUDED
- NYLON D-RINGS AND 18.5CM X 18.5CM DIVE FLAG



HYDRO FLAT

Code: 425720

RRP
€ 84.00

- FLAT BUOY WITH RUGGED OUTER COVER
- 500D ORANGE PVC OFFERING GREAT RESISTANCE, VISIBILITY AND A SMOOTH SURFACE FOR EASE OF MOVEMENT
- 7 NYLON D-RINGS
- 20 METERS OF FLOAT LINE + NYLON SNAP INCLUDED
- 30.5CM X 30.5CM DIVE FLAG



HYDRO SPHERE

Code: 425719

RRP
€ 40.00

- BUOY WITH A RUGGED OUTER COVER
- 500D ORANGE PVC OFFERING GREAT RESISTANCE, VISIBILITY AND A SMOOTH SURFACE FOR EASE OF MOVEMENT
- 20 METERS OF FLOAT LINE + NYLON SNAP INCLUDED
- NYLON D-RINGS AND 18.5CM X 18.5CM DIVE FLAG



TORPEDO

Code: 425713

RRP
€ 28.00

- BUOYS MADE OF RESILIENT PVC
- FASTENING RINGS ON THE BOTTOM
- INCLUDES 20 METERS OF LINE AND CARABINER



SPHERE

Code: 425714

RRP
€ 17.90

- BUOYS MADE OF RESILIENT PVC
- FASTENING RINGS ON THE BOTTOM
- INCLUDES 20 METERS OF LINE AND CARABINER



APNEA

Code: 425711

RRP
€ 32.00

- BUOY MADE OF RESILIENT PVC
- FEATURES A PEAK WITH RING
- DRAG POINT OPTIMIZED TO INCREASE GLIDE OVER THE WATER



BUOY REEL HYDRO

Code: 423860

RRP
€ 45.00

NEW

- DESIGNED SPECIFICALLY FOR MARES SPEARFISHERS
- THE REEL HELPS THE LINE STAY CLEAR
- 30M OF 1.4MM CLEAR NYLON INCLUDED
- TO BE USED WITH A BUOY AND QUICK RELEASE WEIGHT 425860



DIVE FLAG

Code: 45200412

RRP
€ 6.00

- FLAG SIZE: 18.5 X 18.5 CM
- CAN BE MOUNTED ON THE HYDRO TORPEDO (425718) AND THE HYDRO SPHERE (425719)



DIVE FLAG ALPHA

Code: 45200449

RRP
€ 9.00

NEW

- FLAG SIZE: 30 X 20 CM

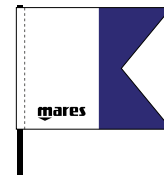

LINE HOLDER

Code: 423946

RRP
€ 7.90

- KEEP YOUR SPEARFISHING LINE ORDERLY WITH MARES' LINE HOLDER



SAFETY WHISTLE

Code: 423930

RRP
€ 5.00



TRAINING BUOY

Code: 425715

RRP
€ 145.00



- FOUR OUTSIDE HANDLES FOR PRE-DIVE PREPARATION
- AMPLE INSIDE SPACE TO CONTAIN THE LINE DURING TRANSPORTATION
- EXTERNAL POCKET WITH ZIP
- ORAL INFLATOR AND OVER PRESSURE VALVE
- STAINLESS STEEL D-RING FOR TO CONNECT THE FREE DIVING LINE
- 12 HOLES FOR WATER DRAINAGE TOP
- DIVE FLAG (CODE: 45200301) AND FLAG SUPPORT (CODE: 425716) NOT INCLUDED



BOTTOM



TECHNICAL FEATURES

Length	Height	Volume
70 cm	17 cm	48 L

BOTTOM PLATE

Code: 425814

RRP
€ 25.00

- THE BEST FREEDIVING BOTTOM PLATE FOR TRAINING AND COMPETITIONS
- DESIGNED FOR USE WITH Ø 10MM FREEDIVING LINE
- OPTIMAL HYDRODYNAMIC PERFORMANCE THANKS TO ITS SHAPE AND HOLES FOR WATER
- Ø 27CM WHITE PLATE FOR GREAT VISIBILITY FROM A DISTANCE
- CONNECTION HOLES AVAILABLE: 2 FOR ACTION CAMS - 16 FOR VELCRO NAME TAG STRIPS - 32 FOR DEPTH TAGS



HOLDER FOR DIVE FLAG

Code: 425716

RRP
€ 6.00

- DIVE FLAG HOLDER
- CAN BE USED WITH THE TRAINING BUOY (425715)



DIVE FLAG 30.5 X 30.5 CM

Code: 45200301

RRP
€ 6.00

- SPARE PART FOR TECH BUOYS
- FLAG: 30.5 X 30.5CM



NOSE CLIP

Code: **423974**

RRP
€ 29.90



- ERGONOMIC SHAPE FOR HANDS-FREE COMPENSATION
- LIGHT AND COMPACT
- SOFT OVER MOLDED AREA FOR MAXIMUM GRIP AND COMFORT
- CAN BE APPLIED ON THE MASK OR NOSE
- IDEAL FOR SWIMMING AND FREEDIVING IN ALL ENVIRONMENTS
- SYMMETRICALLY FORMED
- ADJUSTABLE LANYARD



COLLAR

Code: **425864** ♦ Weight 300g

RRP
€ 12.90

Code: **425865** ♦ Cordura Strap

RRP
€ 15.50

Code: **425866** ♦ Silicone Strap

RRP
€ 13.00



- SOPHISTICATED FREEDIVING WEIGHT COLLAR SYSTEM
- 300G WEIGHTS WHICH CONNECT INDIVIDUALLY
- EASY WEIGHT ADJUSTMENT
- WHITE WEIGHTS FOR BETTER VISIBILITY AND NICE DESIGN
- TWO ADJUSTABLE STRAPS: CORDURA OR SILICONE
- BUCKLES ARE DESIGNED FOR SIMPLE AND INTUITIVE USE



LANYARD FREEDIVING

Code: **423992 - Lanyard Freediving**

RRP
€ 79.00

Code: **423995 - Lanyard Freediving with snap release**

RRP
€ 82.00



- RELEASABLE SAFETY CABLE
- SAFETY RELEASE SYSTEM ON THE BRACELET
- STAINLESS STEEL SNAP HOOK
- COATED STEEL CABLE, YELLOW COLOR AND 100CM LONG
- TWO SWIVELS AT THE EXTREMITIES OF THE CABLE
- THE LANYARD IS MANDATORY IN COMPETITION, AND RECOMMENDED DURING COURSES AND TRAINING



NEOPRENE CAP

NEW

Code: **425869**

RRP
€ 29.00



- MADE IN 2MM NEOPRENE
- FULLY WIND/WATERPROOF
- SMOOTHSKIN NEOPRENE 'WATER-STOP' BAND INSIDE
- ADJUSTABLE VELCRO® BRAND CLOSURE AT THE BACK
- ONE SIZE



SWIM APNEA CAP

Code: 425868

RRP
€ 4.90



- A SILICONE SWIMMING CAP FOR FREEDIVING COMPETITIONS



BELT ELASTIC W/NYLON BUCKLE

Code: 425812 WH/BK

RRP
€ 26.00

- QUICK-RELEASE NYLON BUCKLE
- 3 MM ELASTIC TAPE, 140 CM LONG



FAST D-RING

Code: 425811

RRP
€ 15.00

- 4 PCS



UNDERWATER SLATE

Code: 415719

RRP
€ 13.90

- BRIGHT WHITE WRITING SLATE
- COMPACT SIZE: 12 X 15CM
- HOOK SYSTEM TO ATTACH TO YOUR BCD
- QUICK RELEASE BUCKLE
- STANDARD REPLACEABLE PENCIL WITH SILICONE TUBE



QUICK-RELEASE WEIGHT

Code: 425860

RRP
€ 30.00

- 1 KG QUICK-RELEASE WEIGHT, FAST AND EASY TO USE
- IDEAL FOR BUOYANCY CHANGES
- EXCLUSIVE MARES PATENT



BELT ELASTIC W/MARSEILLAISE S.S

Code: 425813 WH/BK

RRP
€ 39.00

- STAINLESS STEEL, QUICK-RELEASE BUCKLE
- 3 MM ELASTIC TAPE, 140 CM LONG



SNAP HOOK

Code: 423945

RRP
€ 4.20

- 2 PCS



PERSONAL DRY BOX

Code: 415727

RRP
€ 13.50

- LANYARD FOR TRANSPORTATION
- DRY SEAL FOR WATERTIGHT CLOSURE
- SLEEK DESIGN
- SMALL AND DURABLE





MULTIPRONGS MARES PRO



Code: 423724 3P / 4P / 5P

- HIGHLY HYDRODYNAMIC SHAPE
- GREAT SPEED AND STABILITY, EVEN ON LONGER SHOTS
- THE SPECIAL PRONG ANGLE MEANS GREATER HOLDING POWER TO RESTRAIN PREY
- BLACK PLASTIC BASE WITH RESISTANT TECHNOPOLYMER
- MUSTAD® PRONGS
- THREAD M7
- PACK OF 10PCS



MULTIPRONGS MARES



Code: 423725 ♦ - 3P/4P/5P

- HIGHLY HYDRODYNAMIC SHAPE
- GREAT SPEED AND STABILITY, EVEN ON LONGER SHOTS
- SPECIAL PRONG ANGLE
- THE ANGLED PRONGS MEAN GREATER HOLDING POWER TO RESTRAIN PREY
- WHITE PLASTIC BASE WITH RESISTANT TECHNOPOLYMER
- MUSTAD® PRONGS
- THREAD M7
- PACK OF 10PCS



INOX MULTIPRONGS

Code : 423719 3P

RRP
€ 9.90

- STAINLESS STEEL
- BLACK NYLON BASE
- THREAD M7



Code : 423720 5P

RRP
€ 9.90

- STAINLESS STEEL
- BLACK NYLON BASE
- THREAD M7



MULTIPRONGS PROTECTOR

Code : 45200320

RRP
€ 29.00

- PROTECTION FOR THREE, FOUR AND FIVE PRONGED MARES MULTIPRONGS
- PACK OF 10PCS

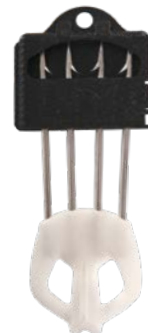

BULLET 1 BARB

Code : 423726 ♦

- GALVANIZED STEEL PR80
- 10 PCS
- THREAD M7



BULLET 2 BARB

Code : 423727 ♦

- GALVANIZED STEEL PR80
- 10 PCS
- THREAD M7



BULLET PRO

Code : 423728 ♦

- TEMPERED STAINLESS STEEL
- 10 PCS
- THREAD M7



BULLET MINI

Code : 423729 ♦

- STAINLESS STEEL
- 10 PCS
- THREAD M7



SHAFT / GUIDE

SLG	Sling Gun
PNG	Pneumatic Gun
FINS	'Shark Fin' spear loading point
TRI-FILED	Spear tip finish

NOTE:
All shafts are in 17-4 PH stainless steel unless otherwise specified.

TIP PROTECTION

Code : 43200496

RRP
€ 1,00

- ONLY FOR MARES SHAFTS



SHAFTS FOR PNEUMATIC GUNS

PNG TAHITIAN SHAFT 8

Code: 423265 ♦



DIAMETER : Ø 8 mm		
GUN MODEL: Cyrano 1.3		
LENGTH	GUN SIZE	RRP
97 cm	90	€ 40.00
107 cm	100	€ 43.00
122 cm	110	€ 46.00
132 cm	120	€ 48.00

PNG TAHITIAN SHAFT 7

Code: 423257



DIAMETER : Ø 7 mm		
GUN MODEL: Cyrano 1.1 HFT - Cyrano 1.1		
LENGTH	GUN SIZE	RRP
97 cm	97	€ 36.00
107 cm	107	€ 39.00
122 cm	122	€ 42.00
132 cm	132	€ 44.00

SHAFTS FOR PNEUMATIC GUNS

PNG THREAD SHAFT 8 ZINC COATED

Code: 423259



DIAMETER: Ø 8 mm

TYPE: Thread M7

GUN MODEL: Sten - Jet - Cyrano 1.3

LENGTH	GUN SIZE	RRP
36.9 cm	42	€ 13.50
51.9 cm	55	€ 13.90
66.9 cm	70	€ 17.30

GUN MODEL: Sten

LENGTH	GUN SIZE	RRP
86.9 cm	90	€ 17.80
98.4 cm	100	€ 18.20

PNG THREAD SHAFT 7 ZINC COATED

Code: 423258 ♦



DIAMETER: Ø 7 mm

TYPE: Thread M7

GUN MODEL: Cyrano 1.1

LENGTH	GUN SIZE	RRP
35.9 cm	42	€ 24.00
86.5 cm	90	€ 26.00
96.5 cm	100	€ 26.50
106.5 cm	110	€ 27.00

GUN MODEL: Cyrano 1.1 - Sten 11

LENGTH	GUN SIZE	RRP
56.9 cm	55	€ 25.00
67.1 cm	70	€ 25.50

PNG THREAD SHAFT 8

Code: 423260 ♦



DIAMETER: Ø 8 mm

TYPE: Thread M7

GUN MODEL: Sten - Jet - Cyrano 1.3

LENGTH	GUN SIZE	RRP
36.9 cm	42	€ 18.50
51.9 cm	55	€ 19.50
66.9 cm	70	€ 20.50

GUN MODEL: Sten

LENGTH	GUN SIZE	RRP
86.9 cm	90	€ 22.00
98.4 cm	100	€ 23.00

SHAFTS FOR SLING GUNS

SLG SHAFT FINS 6.5 TRI-FILED

Code: 423266 ♦

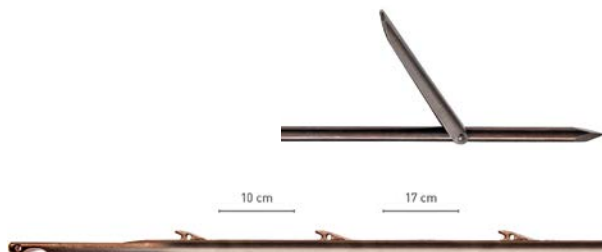

DIAMETER: Ø 6.5 mm		
GUN MODEL: Viper - ViperPro DS		
LENGTH	GUN SIZE	RRP
115 cm	75	€ 51.00
130 cm	90	€ 55.00
140 cm	100	€ 59.00
150 cm	110	€ 63.00
160 cm	120	€ 67.00

SLG SHAFT FINS 7 TRI-FILED

Code: 423264 ♦



DIAMETER: Ø 7 mm		
GUN MODEL: Viper - ViperPro DS		
LENGTH	GUN SIZE	RRP
115 cm	75	€ 58.50
130 cm	90	€ 62.00
140 cm	100	€ 66.00
150 cm	110	€ 69.50
160 cm	120	€ 73.00

SLG SHAFT FINS 6.5

Code: 423254 ♦

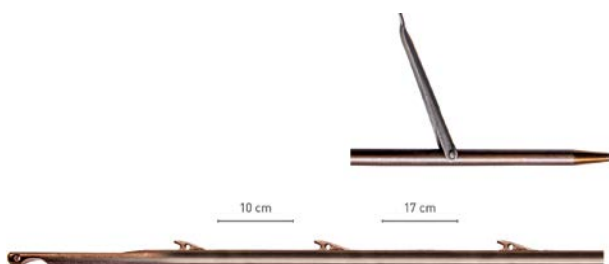

DIAMETER: Ø 6.5 mm		
GUN MODEL: Viper - Viper Pro DS		
LENGTH	GUN SIZE	RRP
115 cm	75	€ 46.00
130 cm	90	€ 49.50
140 cm	100	€ 53.00
150 cm	110	€ 57.00
160 cm	120	€ 61.00

SLG SHAFT FINS STRIKE 6.5

NEW

Code: 423267

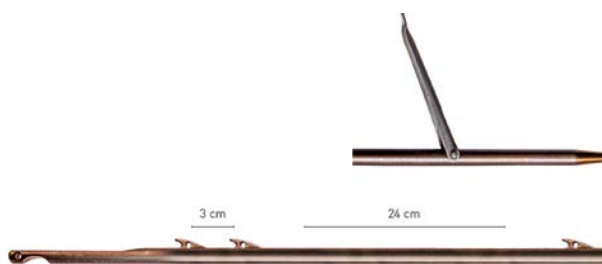

DIAMETER: Ø 6.5 mm		
GUN MODEL: Strike - Strike Element - Strike Polygon - Viper Pro - Viper Pro DS		
LENGTH	GUN SIZE	RRP
95 cm	55	€ 52.50
115 cm	75	€ 56.50
130 cm	90	€ 60.00
140 cm	100	€ 64.00
150 cm	110	€ 67.50
155 cm	115	€ 71.00
160 cm	120	€ 75.00

SHAFTS FOR SLING GUNS

SLG SHAFT FINS STRIKE 7

NEW

Code: 423271

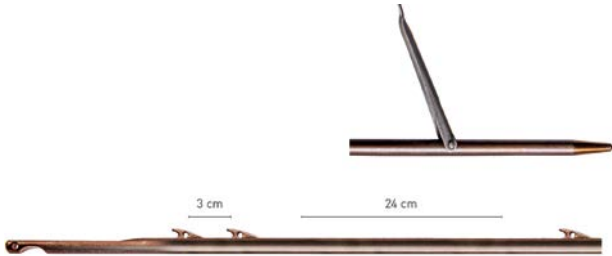

DIAMETER: Ø 7 mm

GUN MODEL: Strike - Strike Element - Strike Polygon - Viper Pro - Viper Pro DS

LENGTH	GUN SIZE	RRP
95 cm	55	€ 52.50
115 cm	75	€ 56.50
130 cm	90	€ 60.00
140 cm	100	€ 64.00
150 cm	110	€ 67.50
155 cm	115	€ 71.00
160 cm	120	€ 75.00

SLG SHAFT 6.5

Code: 423226 ♦



DIAMETER: Ø 6.5 mm

GUN MODEL: Sniper - Sniper PS - Sniper Alpha - Sniper Pro

LENGTH	GUN SIZE	RRP
85 cm	45	€ 35.00
115 cm	75	€ 37.00
130 cm	90	€ 39.00
140 cm	100	€ 40.00
150 cm	110	€ 42.00
160 cm	120	€ 44.00

SLG SHAFT FINS STRIKE 6

NEW

Code: 423270

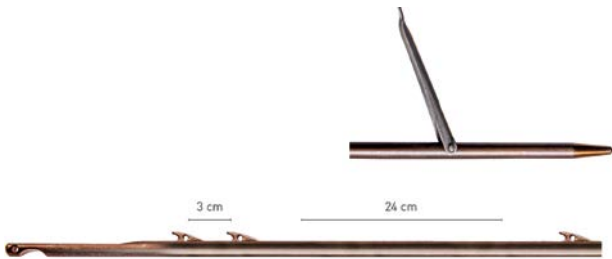

DIAMETER: Ø 6 mm

GUN MODEL: Strike - Strike Element - Strike Polygon - Viper Pro - Viper Pro DS

LENGTH	GUN SIZE	RRP
95 cm	55	€ 50.00
115 cm	75	€ 54.00
130 cm	90	€ 57.00
140 cm	100	€ 61.00
150 cm	110	€ 65.00
155 cm	115	€ 69.00
160 cm	120	€ 73.00

SHAFTS FOR SLING GUNS

SLG SHAFT 6.25

Code: 423263 ♦



DIAMETER: Ø 6.25 mm

GUN MODEL: Sniper - Sniper PS - Sniper Alpha - Sniper Pro

LENGTH	GUN SIZE	RRP
85 cm	45	€ 30.50
115 cm	75	€ 32.50
130 cm	90	€ 34.50
140 cm	100	€ 35.50
150 cm	110	€ 37.50

SLG SHAFT 6

Code: 423262 ♦



DIAMETER: Ø 6 mm

GUN MODEL: Sniper - Sniper PS - Sniper Alpha - Sniper Pro

LENGTH	GUN SIZE	RRP
85 cm	45	€ 30.00
115 cm	75	€ 31.00
130 cm	90	€ 32.00
140 cm	100	€ 33.00
150 cm	110	€ 34.00

SLG SHAFT 6.5 ZINC COATED

Code: 423256



DIAMETER: Ø 6.5 mm

GUN MODEL: Sniper - Sniper PS - Sniper Alpha - Sniper Pro

LENGTH	GUN SIZE	RRP
75 cm	35	€ 19.50
85 cm	45	€ 21.50
115 cm	75	€ 23.50
130 cm	90	€ 25.50
140 cm	100	€ 27.50
150 cm	110	€ 29.50

SLG THREAD SHAFT 7 ZINC COATED

Code: 423255



DIAMETER: Ø 7 mm

GUN MODEL: Sniper - Sniper PS - Sniper Alpha - Sniper Pro

LENGTH	GUN SIZE	RRP
58 cm	35	€ 16.50
68 cm	45	€ 17.50
78 cm	55	€ 18.50
98 cm	75	€ 19.50
113 cm	90	€ 20.50

LATEX S-POWER ROLL



- TWO-MATERIAL MARES S-POWER LATEX
- THIN BROWN/INDIGO/GOLD UV PROTECTION OUTSIDE AND NATURAL AMBER LATEX INSIDE
- PROGRESSIVE LATEX AND CONSTANT POWER OVER THE LONG TERM
- 5-METER ROLL



	DIAMETER	COLOR	LENGTH	RRP
Code : 423989	Ø 14 mm	BROWN	5 meter roll	€ 93.00
Code : 423977 NEW	Ø 14 mm	INDIGO		-
Code : 423978 NEW	Ø 15 mm	GOLD		-
Code : 423990	Ø 16,5 mm	BROWN		€ 135.00
Code : 423991 ♦	Ø 18 mm	BROWN		€ 160.00

INDIGO /BROWN

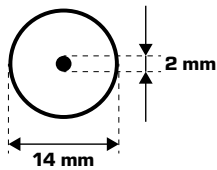

GOLD

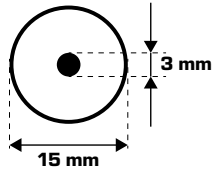

BROWN

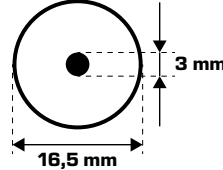

BROWN

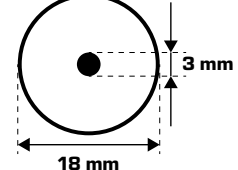

SLING DISPENSER

NEW

Code : 423979

- THE SMART SOLUTION FOR SLINGS
- 3-SECTION SLING DISPENSER
- DESIGNED FOR SLINGS WITH A DIAMETER OF 12 TO 20MM
- SLINGS NOT INCLUDED



S-POWER SLINGS PAIR

- MARES S-POWER LATEX
- CONICAL RING PREVENTS THE PARACHUTE EFFECT AND INCREASES THE SPEED

Code : **423957****DIAMETER: Ø 16 mm**

GUN MODEL: Sniper PS

LENGTH	GUN SIZE	RRP
16 cm	45	€ 14.00
19 cm	55	€ 15.00
22 cm	75	€ 16.00
24 cm	90	€ 17.00
26 cm	100	€ 18.00

Code : **423958****DIAMETER: Ø 17.5 mm**

GUN MODEL: Sniper PS

LENGTH	GUN SIZE	RRP
16 cm	45	€ 16.00
19 cm	55	€ 17.00
22 cm	75	€ 18.00
24 cm	90	€ 19.00
26 cm	100	€ 20.00
28 cm	110	€ 21.00

Code : **423962** ♦**DIAMETER: Ø 19 mm**

GUN MODEL: Sniper PS

LENGTH	GUN SIZE	RRP
19 cm	45	€ 19.00
22 cm	55	€ 20.00
24 cm	75	€ 21.00
26 cm	90	€ 22.00
28 cm	100	€ 23.00

S-POWER SLINGS CIRCULAR

- MARES S-POWER LATEX
- CONICAL RING PREVENTS THE PARACHUTE EFFECT AND INCREASES THE SPEED

Code : **423970****DIAMETER: Ø 14 mm**

GUN MODEL: Sniper - Sniper Alpha - Sniper Pro

LENGTH	GUN SIZE	RRP
28 cm	35	€ 13.00
30 cm	45	€ 14.00
34 cm	55	€ 15.00
50 cm	75	€ 16.00

Code : **423963****DIAMETER: Ø 16 mm**

GUN MODEL: Sniper - Sniper Alpha

LENGTH	GUN SIZE	RRP
30 cm	Sniper 45 / Sniper Alpha 35	€ 12.00
34 cm	Sniper 55	€ 13.00
42 cm	Sniper Alpha 45	€ 14.00
44 cm	Sniper Alpha 55	€ 15.00
50 cm	Sniper 75	€ 16.00
55 cm	Sniper Alpha 75	€ 17.00
60 cm	Sniper 90	€ 18.00

Code : **423959****DIAMETER: Ø 17.5 mm**

GUN MODEL: Sniper - Sniper Pro

LENGTH	GUN SIZE	RRP
34 cm	45	€ 14.00
42 cm	55	€ 15.00
48 cm	75	€ 16.00
55 cm	90	€ 17.00
60 cm	100	€ 18.00
65 cm	110	€ 19.00

Code : **423964** ♦**DIAMETER: Ø 19 mm**

GUN MODEL: Sniper - Sniper Pro

LENGTH	GUN SIZE	RRP
48 cm	75	€ 17.00
60 cm	90	€ 18.00
65 cm	100	€ 19.00
70 cm	110	€ 20.00

S-POWER SLINGS SPEED CIRCULAR / BLACK

- MARES S-POWER LATEX
- INTERCHANGEABLE WISHBONE IN 2 mm DYNEEMA®
- DESIGNED FOR SHAFTS WITH SPECIALLY POLISHED NOTCHES, PINS OR SHARK FINS
- NO PARACHUTE EFFECT, INCREASES SPEED

Code: **423966****DIAMETER: Ø 16 mm****GUN MODEL: Viper Pro - Viper Pro DS**

LENGTH	GUN SIZE	RRP
42 cm	75	€ 14.00
50 cm	90	€ 15.00
55 cm	100	€ 16.00
60 cm	110	€ 17.00
65 cm	120	€ 18.00

Code: **423960****DIAMETER: Ø 17.5 mm****GUN MODEL: Viper Pro - Viper Pro DS**

LENGTH	GUN SIZE	RRP
42 cm	55	€ 15.00
48 cm	75	€ 16.00
55 cm	90	€ 17.00
60 cm	100	€ 18.00
65 cm	110	€ 19.00
70 cm	120	€ 20.00

Code: **423965** ♦**DIAMETER: Ø 19 mm****GUN MODEL: Viper Pro - Viper Pro DS**

LENGTH	GUN SIZE	RRP
60 cm	100	€ 23.00
65 cm	110	€ 25.00
70 cm	120	€ 27.00

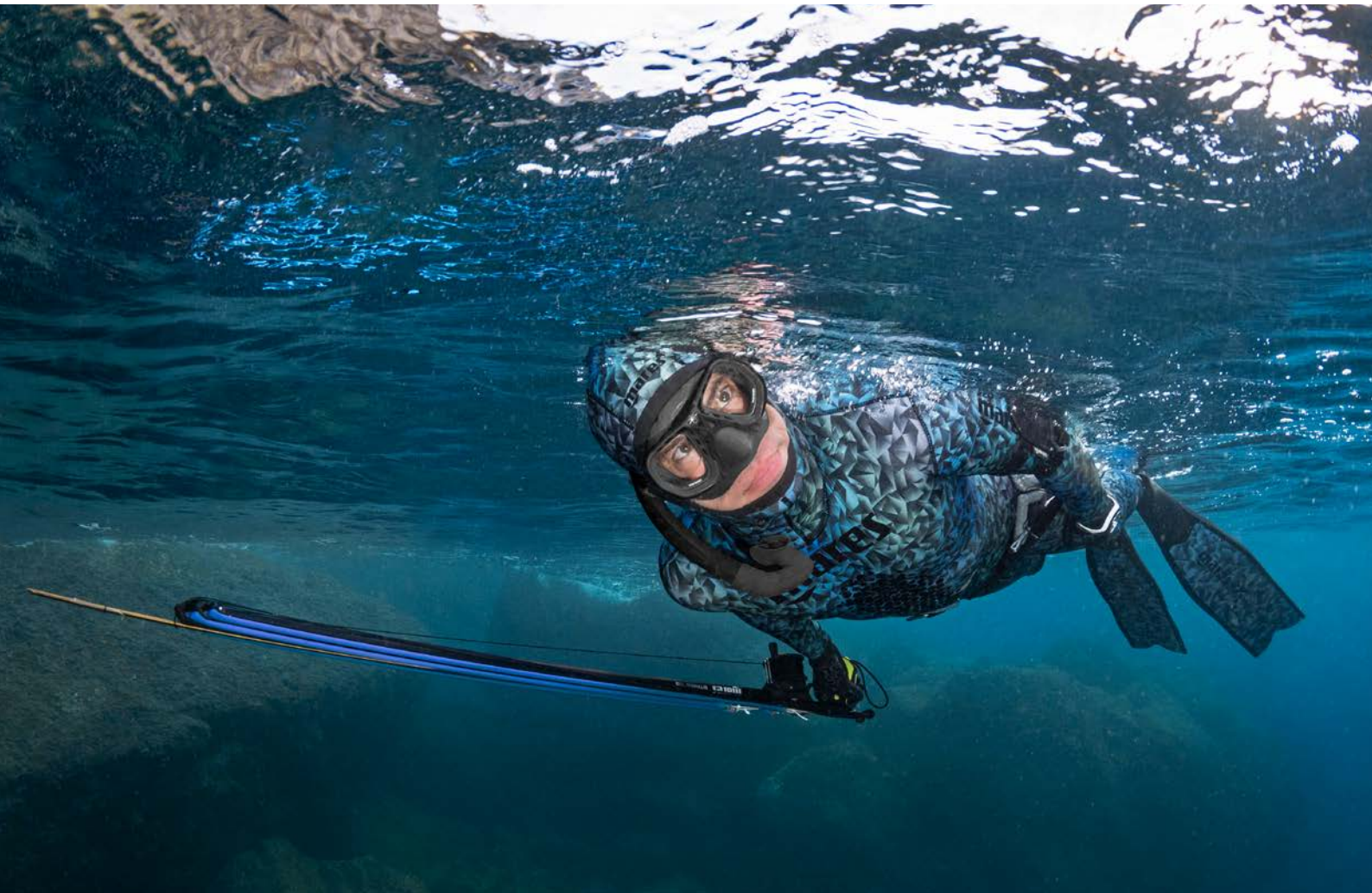

S-POWER SLINGS SPEED CIRCULAR / PROGRESSIVE

- TWO-MATERIAL MARES S-POWER LATEX
- THIN, BROWN/INDIGO LATEX UV PROTECTION OUTSIDE AND NATURAL AMBER LATEX INSIDE
- PROGRESSIVE LATEX SLING OFFERING CONSTANT POWER OVER THE LONG TERM
- INTERCHANGEABLE WISHBONE IN 2 MM DYNEEMA®
- DESIGNED FOR SHAFTS WITH SPECIALLY POLISHED NOTCHES, PINS OR SHARK FINS
- NO PARACHUTE EFFECT, INCREASES SPEED

Code: **423870****DIAMETER: Ø 14 mm / COLOR: BROWN****GUN MODEL: Viper Pro - Viper Pro DS**

LENGTH	GUN SIZE	RRP
42 cm	75	€ 9.00
48 cm	90	€ 10.00
55 cm	100	€ 11.00
60 cm	110	€ 12.00
65 cm	120	€ 13.00
70 cm	130	€ 14.00

Code: **423871****DIAMETER: Ø 16.5 mm / COLOR: BROWN****GUN MODEL: Viper Pro - Viper Pro DS**

LENGTH	GUN SIZE	RRP
42 cm	55	€ 11.00
48 cm	75	€ 12.00
55 cm	90	€ 13.00
60 cm	100	€ 14.00
65 cm	110	€ 15.00
70 cm	120	€ 16.00

Code: **423872****DIAMETER: Ø 18 mm / COLOR: BROWN****GUN MODEL: Viper Pro - Viper Pro DS**

LENGTH	GUN SIZE	RRP
42 cm	55	€ 13.00
48 cm	75	€ 14.00
55 cm	90	€ 15.00
60 cm	100	€ 16.00
65 cm	110	€ 17.00
70 cm	120	€ 18.00

Code: **423874****NEW****DIAMETER: Ø 14 mm / COLOR: INDIGO****GUN MODEL: Strike - Strike Element - Strike Polygon**

LENGTH	GUN SIZE	RRP
42 cm	55	€ 10.00
50 cm	75	€ 11.00
58 cm	90	€ 12.00
64 cm	100	€ 13.00
72 cm	115	€ 14.00

Code: **423873****NEW****DIAMETER: Ø 17 mm / COLOR: INDIGO****GUN MODEL: Strike - Strike Element - Strike Polygon**

LENGTH	GUN SIZE	RRP
42 cm	55	€ 13.00
54 cm	75	€ 15.00
63 cm	90	€ 17.00
70 cm	100	€ 19.00
75 cm	115	€ 21.00

SLING GUN TEST



Mares products undergo rigorous testing to ensure superior quality and performance. Metal objects are inserted into machines simulating various environmental exposures, including cycles of saline mist. This helps us choose the best materials to prevent oxide formation and environmental degradation.

The slings on the gun, including the shooting line, and shaft fins, are put through traction tests using a machine that illustrates power imparted and deformation based upon kilos of thrust delivered.

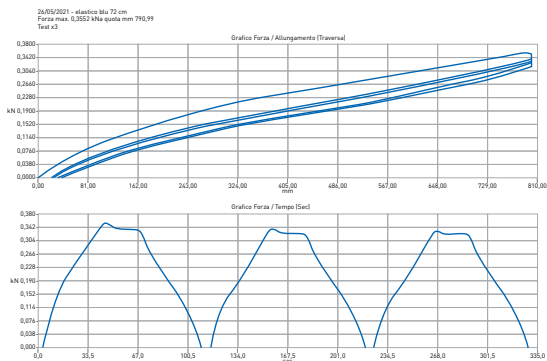

The trigger mechanism for sling spearguns is designed using a test bench device. This machine evaluates kilos of pressure for pulling the trigger in relation to the load on the shaft. This is simulated with different slings loaded simultaneously while giving a precise reading of the trigger performance.



ARTICULATED BIND WISHBONE

Code : 423915 ♦



ARTICULATED WISHBONE

Code : 423914



LARIO BIND WISHBONE

Code : 423913 ♦



LARIO WISHBONE

Code : 423912



RACE WISHBONE

Code : 423967



WISHBONE TOOL

Code : 423940 ♦



SPEED

Code : 423911

- CONNECTOR END MADE OF SPECIAL 2 mm DYNEEMA® LINE
- DESIGNED FOR SHAFTS WITH SPECIALLY POLISHED NOTCHES, PINS OR SHARK FINS
- NO PARACHUTE EFFECT, INCREASES SPEED



SPEED2

Code : 423916

- CONNECTOR END MADE OF SPECIAL 2 mm DYNEEMA® LINE
- DESIGNED FOR SHAFTS WITH SPECIALLY POLISHED NOTCHES, PINS OR SHARK FINS
- NO PARACHUTE EFFECT, INCREASES SPEED



SPEED3

Code : 423936

- CONNECTOR END MADE OF SPECIAL 2 mm DYNEEMA® LINE
- DESIGNED FOR SHAFTS WITH SPECIALLY POLISHED NOTCHES, PINS OR SHARK FINS
- NO PARACHUTE EFFECT, INCREASES SPEED

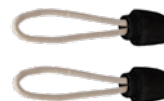

PAIR OF SLINGS SUPPORT

Code : 423944 ♦



LINE DYNEEMA

Code : 423993

- SPECIAL 2mm DYNEEMA , THE BEST MATERIAL FOR WISHBONES
- 10 METERS





DIAMOND LINE 1MM

Code: 423922 ♦



TECHNICAL FEATURES

Materials	100% Dyneema core HT Polyester covering	 
Diameter	1 mm	
Resistance	120 kg	
Length of roll	100 meters	

CAMO LINE

Code: 423804



TECHNICAL FEATURES



Materials	HT Polyester covering	
Diameter	1,65 mm	
Resistance	100 kg	
Length of roll	100 meters	

DIAMOND LINE 1,5 MM

Code: 423921



TECHNICAL FEATURES

Materials	100% Dyneema core HT Polyester covering	 
Diameter	1,5 mm	
Resistance	180 kg	
Length of roll	100 meters	

BLACK LINE

Code: 423803



TECHNICAL FEATURES



Materials	HT Polyester covering	
Diameter	1,6 mm	
Resistance	80 kg	
Length of roll	50 meters	

DIAMOND LINE 2MM

Code : 423920



TECHNICAL FEATURES

Materials	100% Dyneema core HT Polyester covering	 
Diameter	2 mm	
Resistance	300 kg	
Length of roll	50 meters	

BLACK MONOLINE

Code : 423931



TECHNICAL FEATURES

Materials	Nylon	
Diameter	1,5 mm	
Resistance	80 kg	
Length of roll	25 meters	

HANDLE GRIP ,KJ'

Code: 423973

RRP
€ 10.90

- PREFORMED GRIP
- BETTER MANAGEABILITY AND EXCELLENT STABILITY
- NEW DESIGN FACILITATES EASIER AIMING
- CAN BE USED ON THE CYRANO EVO, CYRANO EVO HF, VIPER PRO AND VIPER PRO DS



POWER LOADER

Code: 413807

RRP
€ 145.00

- POWER LOADER FOR MARES PNEUMATIC GUNS
- DEDICATED TO SERVICE CENTERS



HP GAUGE

Code: 423947 ♦

RRP
€ 49.00

- HP GAUGE FOR MARES PNEUMATIC GUNS
- WHEN YOU ATTACH THIS ACCESSORY ON THE INLET VALVE, THE GAUGE SHOWS THE PRESSURE OF THE GUN



INJECTOR

Code: 423901

RRP
€ 26.00

- MANUAL AIR INJECTOR FOR MARES PNEUMATIC GUNS



CLEVER LOADER

Code: 423941

RRP
€ 5.50

- MULTI-FUNCTIONAL LOADER FOR SHAFTS FITTED WITH SPEAR TIPS OR MULTIPRONGS
- LOADER ALSO FEATURES TABS FOR UNSCREWING A PNEUMATIC GUN VALVE COVER CAP



LONG CLEVER LOADER

Code: 423942

RRP
€ 16.00

- LONG VERSION OF THE CLEVER LOADER
- IT ALLOWS THE USER TO LOAD PNEUMATIC GUNS SAFELY AND EASILY



LINE SLIDER RACE

Code: 423937 ♦ 8mm

Code: 423938 ♦ 7mm

RRP
-

- COMPACT HYDRODYNAMIC LINE SLIDER
- FOR PNEUMATIC GUNS WITH A 7MM / 8MM SHAFT
- PACK OF 5PCS



SLING PROTECTION

Code: 423939

RRP
€ 14.00

- INTENDED FOR USE ON SLING GUNS WHEN NOT IN USE
- HELPS SAFEGUARD AGAINST PREMATURE AGING OF THE SLINGS DUE TO EXPOSURE TO THE SUN



VERTICAL SPIRO 65

Code: **423933**

- 65 mm SPOOL
- DESIGNED SPECIFICALLY FOR MARES SPEARGUNS
- THE LINE GUIDE ON THE REEL HELPS THE LINE PASS SNUGLY ALONG THE OUTER BARREL
- MARES PATENTED CLUTCH



TECHNICAL FEATURES

Cyrano 1.1 HFT - Cyrano 1.1 - Cyrano 1.3 - Viper Pro - Viper Pro DS - Sniper - Sniper Pro - Sniper PS - Sniper Alpha				
423804 Camo line Ø 1,6mm - 80kg	423803 Black line Ø 1,65mm - 100kg	423922 Diamond line Ø 1mm - 130kg	423921 Diamond line Ø 1,5mm - 180kg	423920 Diamond line Ø 2mm - 300kg
30 m	30 m	55 m	35 m	20 m

VERTICAL SPIRO 87

Code: **423934**

- 87 mm SPOOL
- DESIGNED SPECIFICALLY FOR MARES SPEARGUNS
- THE LINE GUIDE ON THE REEL HELPS THE LINE PASS SNUGLY ALONG THE OUTER BARREL
- MARES PATENTED CLUTCH



TECHNICAL FEATURES

Cyrano 1.1 HFT - Cyrano 1.1 - Cyrano 1.3 - Viper Pro - Viper Pro DS - Sniper - Sniper Pro - Sniper PS - Sniper Alpha				
423804 Camo line Ø 1,6mm - 80kg	423803 Black line Ø 1,65mm - 100kg	423922 Diamond line Ø 1mm - 130kg	423921 Diamond line Ø 1,5mm - 180kg	423920 Diamond line Ø 2mm - 300kg
60 m	60 m	85 m	65 m	40 m

REEL FOR STRIKE

NEW

Code: **423980**

RRP
€ 35.00

- LINE NOT INCLUDED



REEL

Code: **423856**

- 85 mm SPOOL
- DEDICATED TO STEN - STEN 11 - JET



BARB KEEPER O-RING

Code: **423926**

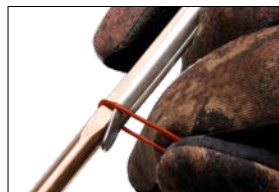

BUNGEE WITH BIG CARABINER

Code: **423935**

- L



BUNGEE

Code: **423923**

- M-L



SLEEVES PLIER

Code : **423968**

RRP
€ 35.00



SLEEVES KIT

Code : **423924** - 20 pcs for Monoline 1,4 / 1,6 mm

Code : **423925** - 20 pcs for Monoline 1,2 / 1,4 mm



CAMERA BRACKET FOR STRIKE GUNS

Code: **423976**

RRP
€ 35.00

- ATTACHMENT POINT FOR VIDEO & CAMERA GEAR
- MOUNTS TO MARES' STRIKE SERIES OF GUNS
- EASY CONNECTION
- LEFT/RIGHT POSITIONING



NEW

CAMERA BRACKET FOR VIPER

Code: **423948**

- ATTACHMENT POINT FOR VIDEO & CAMERA GEAR
- MOUNTS TO MARES GUNS THAT HAVE VERTICAL SPIRO REELS



CAMERA BRACKET FOR PNEUMATIC GUNS

Code: **423971**

RRP
€ 36.00

- FOR Ø 40 mm O.D. BARRELS



CONNECTING KNOB FOR CAMERA

Code: **423949**

- THREAD UNC 1/4"



SHARK CLIP WITH SWIVEL

Code: 423969

RPP
€ 9.50



ANTIFOG

Code : 415101

RPP
€ 11.50

■ 60 ml



NEOPRENE GLUE

Code: 415108

RPP
€ 12.50

■ 20 ml



SILICONE GREASE

Code: 415102

RPP
€ 13.00

■ 20 ml





PASSED

6
552

GENIUS

DEPTH MOD
0.0 57.7
99%
D-TIME 0: 85/85
MARES

mares

SEMINARS 2022



THE MARES LAB SERVICE TECHNICIAN TRAINING PROGRAM

Mares Service Technician Training Courses are available throughout the world and are designed and developed based on proven effective instructional system design principals. They are the dive industry's first and only competency based service technician training courses offered worldwide that are produced and conducted by a major dive equipment manufacturer. This means you'll receive the same high quality and educationally valid training regardless of where in the world you participate in a Mares Service Technician Training Course.

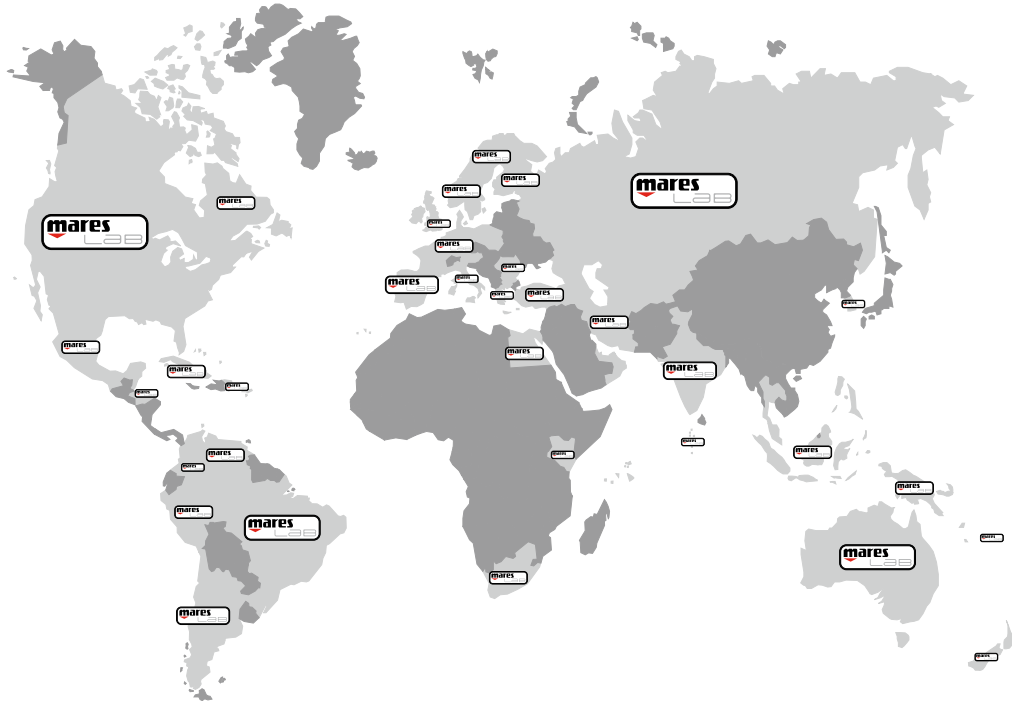

BASIC SERVICE TECHNICIAN DIGITAL LEARNING COURSE

This highly interactive online digital learning course is delivered to the learner using the latest Educational Management System (EMS) technology. The EMS platform technology along with extensive use of video and graphic content enhances learning and retention of information and produces a highly enjoyable educational experience. The course is open to anyone, and can be accessed by contacting the local Mares Subsidiary or Distributor. Take this course as the first step to becoming a fully qualified Mares Service Technician, or if you simply want to learn the basics of regulator design and service and/or repair. This course is a prerequisite requirement for most Mares Lab Skill Based Training Courses. Completion of this course does not qualify you to service or repair Mares equipment.



The course goals are to:

1. Establish your basic knowledge level relating to regulator service and repair procedures.
2. Provide you with basic information about regulator design and function.
3. Provide you with Mares specific information relating to service and repair procedures, manufacturing processes and product information.
4. Help prepare you for success in one or more Mares Lab Skill Based Training Courses.

Prerequisite Requirements:

Course is open to anyone.

MARES LAB SKILL BASED TRAINING COURSES

- MARES SERVICE TECHNICIAN
- MARES DIVING CENTER SERVICE TECHNICIAN
- MARES SPECIALTY SERVICE TECHNICIAN

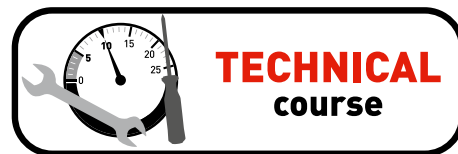

After successfully completing the Basic Service Technician Digital Learning Course, you are now ready to progress to the skill based training phase of becoming a qualified Mares Service Technician. These courses are conducted by qualified Mares Lab Instructors and consist of comprehensive hands-on training exercises. During these courses you will have the opportunity to perform multiple service procedures on a wide variety of Mares products, including multiple complete regulator service overhauls on various Mares regulators. You'll also gain valuable experience in using the Mares Service Manual and Spare Parts Catalog during routine and special service procedures. Skill based training courses are designed to:

1. Provide comprehensive, real world, hands-on training about how to service and repair Mares products.
2. Enhance the knowledge gained from the Basic Service Technician Digital Learning Course.
3. Develop skills and abilities to the level required to successfully perform service and repair procedures on Mares products.
4. Prepare you for a successful full or part-time career as a Mares Service Technician.

SEMINARS 2022



• MARES SERVICE TECHNICIAN

This is by far the most popular of the skill based training courses. The all new and redesigned Mares Service Technician Training Course is a comprehensive 2 day training program that trains and qualifies individuals to service and repair Mares products. Topics include disassembly, reassembly and adjustment of in-line Mares regulators, service and repair procedures, troubleshooting, dive computers, Mares warranty, service guidelines and more. More than 12 hours of course time is dedicated to hands-on, skill based training on how to properly disassemble, reassemble and adjust Mares regulators and BC inflator mechanisms. **Successful completion of this course qualifies you to service and/or repair ALL Mares products.**

Prerequisite Requirements:

Completion of the Basic Service Technician Digital Learning Course.
Be currently affiliated with an Authorized Mares Dealer.
Be approved by the affiliated Mares Dealer to attend the course.

• MARES DIVING CENTER SERVICE TECHNICIAN

This course is designed for technicians who plan to work in a Mares Diving Center, such as a resort or diver training facility, that has limited or no retail sale of Mares equipment. Course duration is 1 day and provides skill based training related to the Mares Diving Center product line. Take this course if you plan to work in a Mares Diving Center and are interested in being able to service and repair your affiliated Mares Diving Center owned Mares products. **Successful completion of the Diving Center Service Technician Course qualifies you to service and repair ONLY your affiliated Diving Center OWNED equipment used in rental and/or training programs.**

Prerequisite Requirements:

Completion of the Basic Service Technician Digital Learning Course.
Be affiliated with an Authorized Mares Diving Center.
Be approved by the affiliated Mares Diving Center to attend the course.

• MARES SPECIALTY SERVICE TECHNICIAN

These courses are designed to train technicians to service and repair specific Mares products. Specialty Service Technician Training Course duration is approximately 1 day, depending on the course requirements and the number of products included in the course. **Successful completion of this course qualifies you to service and/or repair ONLY the specific Mares products for which you were trained.** These products will be listed on your qualification certificate. Contact your local Mares Subsidiary or Distributor for additional information on Specialty Service Technician Training Courses available in your area.

Prerequisite Requirements:

This varies according to the specific Specialty Service Technician Training Course requirements.
Authorization by a current Mares Dive Center or Mares Dealer.

• MARES SERVICE TECHNICIAN UPDATE

In order to maintain your Mares Service Technician qualification, you must attend the Annual Service Technician Online Renewal within one (1) year* of completing a Service Technician Training Course. Annual Service Technician Online Renewals are available online and are conducted regularly every year from October 15th to December 15th.

* Within one (1) year is defined as before December 31st of the year in which the one year limit is reached.

Prerequisite Requirements:

Currently qualified as a Mares Lab Service Technician.
Qualification date is within the one (1) year update requirement.

THE MARES LAB TRAINING CYCLE®

The Mares Lab Training Cycle is a process that has proven effective in producing what we call "best in class results". This means that as a qualified Mares Service Technician, you can be confident that you've successfully completed the dive industry's most comprehensive dive equipment service and repair training program available through a dive equipment manufacturer. You can also be proud of the fact that you earned your qualification by demonstrating a "best in class" level of dive equipment service technician skills and abilities. Here's how the Mares Lab Training Cycle works:

Your Knowledge Development

Your basic dive equipment service and repair knowledge is established during your digital learning course and further enhanced during your skill based training course.

Your Skill Development

Your service and repair skills are enhanced during your skill based training course through a series of hands-on training exercises. Over 90% of the contact hours in these courses are dedicated to skill development.



Your Abilities Confirmed

Your knowledge and skill levels achieved through the Mares Lab training process are objectively evaluated and must meet the minimum core competency requirements in order to be qualified as a Mares Service Technician.

Your Abilities Improved

Your abilities improve over time by gaining additional knowledge and increasing skill levels. This is achieved through experience as a Mares Service Technician, by regular contact and communication with Mares Technical Assistance staff, by receiving periodic product updates and Service Bulletins and by participating in Service Technician Update Seminars.

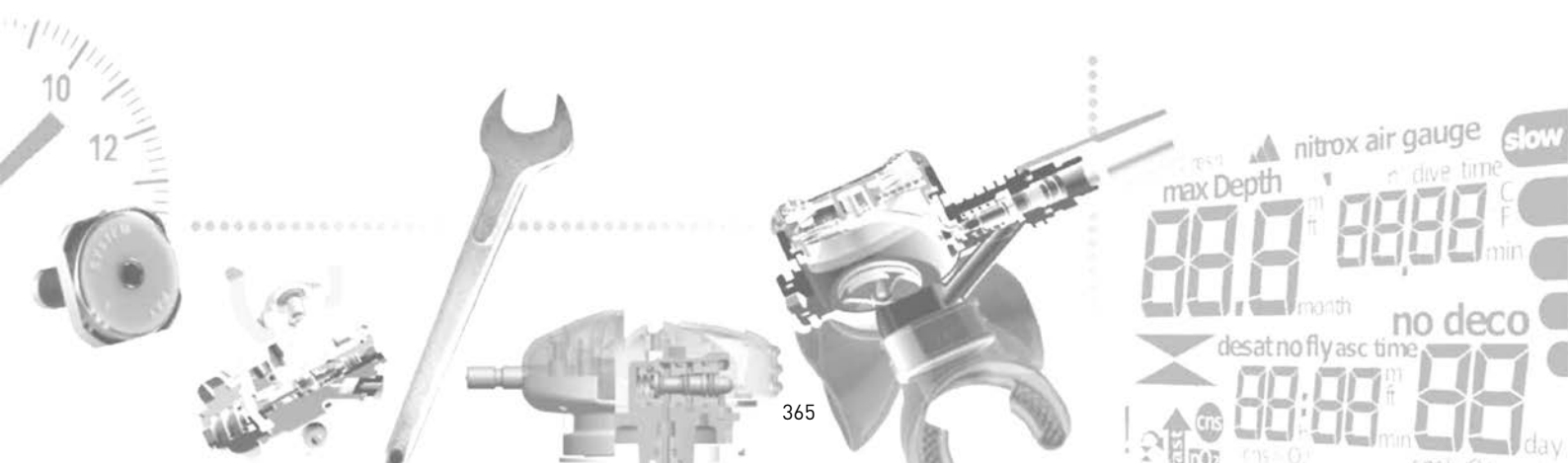

Product specifications and characteristics listed in this catalogue may be subject to changes by Mares without notice.

The trademark **mares**® is a registered trademark.

© **PHOTO CREDITS:** Alberto Balbi - Adv Consulting - Bob Bobisavljevic - Marco Daturi - Massimiliano Eleota - Alex Dawson - Janez Kranjc - Ivana Orlovic Kranjc - Gerald Nowak - Virginia Sotzede - Boaz Samorai - Tom St George - Dejan Subotic - Borislav Turkalj - Fulvio Valgoglio - Predrag Yuckovic - Axel Weiss

ISO 9001:2015 certified

mares



Mares S.p.A.
Salita Bonsen 4
P.O. Box 142
16035 Rapallo (Genova) · ITALY
Tel. +39 0185 2011 / fax +39 0185 201470
www.mares.com